

8510/141-03-131-010 Art. No. 215822



- High availability: Reliable motor contactors: 4 kW/400 V
- Switching in accordance with AC3
- Robust: Anti-vibration components in the corrosion-resistant enclosure

MY R. STAHL 8510C



R. STAHL Series 8510/14 contactors are robust, type-tested standard components for switching motors in accordance with AC3. Easily accessible terminals make installation simple and safe. The enclosure for the anti-vibration screw connection is made of corrosion-resistant material.

Technical Data

Explosion Protection

Application range (zones)	1 2
IECEX gas certificate	IECEX BVS 07.0029U
IECEX gas explosion protection	Ex de IIC
IECEX firedamp certificate	IECEX BVS 07.0029U
IECEX firedamp protection	Ex de I
ATEX gas certificate	DMT 00 ATEX E 073 U
ATEX gas explosion protection	Ex II 2 G Ex de IIC
ATEX firedamp certificate	DMT 00 ATEX E 073 U
ATEX firedamp protection	Ex I M2 Ex de I
Certificates	ATEX (BVS), Brazil (ULB), Canada (FM), China (CQST), IECEX (BVS), USA (FM)

Electrical Data

Rated actuating voltage	24 V AC
Switching capacity	4 kW/400 V AC3
Conventional thermal current	20 A
Main contacts	3-pole (3 NO)
Auxiliary contacts	1 (1 NO)

Ambient Conditions

Ambient temperature	-20 °C ... +60 °C
---------------------	-------------------

Mechanical Data

Degree of protection (IP)	IP20
Enclosure material	Epoxy resin
Max. solid connection terminals	10 mm ²
Connection terminal solid min.	1.5 mm ²
Max. finely stranded connection terminals	6 mm ²
Finely stranded connection terminals min.	1.5 mm ²

8510/141-03-131-010 Art. No. 215822

Mechanical Data

Max. auxiliary contact connection cross-section, solid	2.5 mm ²
Connection cross-section auxiliary contact solid min.	0.75 mm ²
Max. auxiliary contact connection cross section, finely stranded	1.5 mm ²
Connection cross-section auxiliary contact finely stranded min.	0.75 mm ²
Width	80 mm
Height	130 mm
Depth	110.5 mm
Weight	1.62 kg
Weight	3.57 lb

Technical Drawings – Subject to Alterations

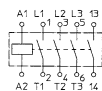

Dimensional Drawings (All Dimensions in mm [inches]) – Subject to Alterations

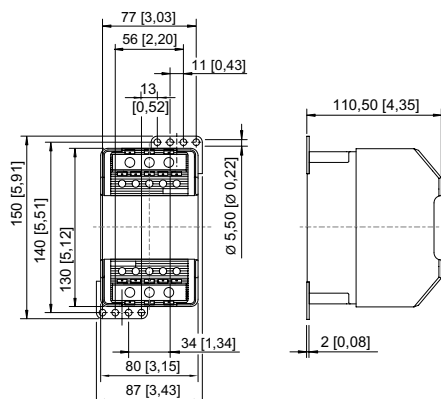

8510/141

We reserve the right to make alterations to the technical data, dimensions, weights, designs and products available without notice. The illustrations cannot be considered binding.