

Control and signalling devices

LED indicator lamp for panel mounting

8013/313-al-3 UL Art. No. 216425



- Beneficial LED technology: Extremely long service life, high luminance, low heat build-up
- For installation in enclosure walls, enclosure covers, panels, control cabinets
- Versions with spring clamp terminal with or without connection chamber or versions with prefabricated connection cable and connection chamber are available

MY R. STAHL 8013A



R. STAHL Series 8013 LED indicator lamps show command statuses via a light signal, the colour of which can be determined using the colour filter included in the delivery: Red, yellow, green, blue or white. The long-lasting LED ensures high luminance and low heat build-up. Versions with spring clamp terminal with or without connection chamber and versions with prefabricated connection cable and connection chamber are available.

Technical Data

Explosion Protection

Scope of validity	European Union (ATEX) CEC IECEX NEC
Application range (zones)	1 2 21 22
IECEX gas certificate	IECEX PTB 07.0010 X
IECEX gas explosion protection	Ex db eb mb IIC T6 Gb
IECEX dust certificate	IECEX PTB 07.0010 X
IECEX dust explosion protection	Ex tb IIIC T80 °C Db
ATEX gas certificate	PTB 02 ATEX 2131 X
ATEX gas explosion protection	⊕ II 2 G Ex db eb mb IIC T6 Gb
ATEX dust certificate	PTB 02 ATEX 2131 X
ATEX dust explosion protection	⊕ II 2 D Ex tb IIIC T80 °C Db
UL gas certificate	E182378V2S3
Certificates	ATEX (PTB), Canada (UL), China (CQST), IECEX (PTB), USA (UL)
Declaration of Conformity	ATEX (EUK), China (CCC)
Notes	Product label may vary. Series devices are labelled with ATEX, IECEX, NEC and CE Code.

Electrical Data

Rated operational voltage AC	12 – 254 V
Rated operational voltage DC	12 ... 254 V
AC UL rated operational voltage	10.8 – 254 V
Voltage tolerance	-10 to +6%
Rated operational current	2.5 mA

Control and signalling devices

LED indicator lamp for panel mounting



8013/313-al-3 UL Art. No. 216425

Electrical Data

Frequency	0 to 60 Hz
Rated operational power	0.6 W
Electrical service life	10 ⁵ lighting hours

Lighting Data

Lamp	White LED
Luminous colour	Blue Green Red White Yellow

Ambient Conditions

Ambient temperature	-30 °C ... +60 °C
Ambient temperature	-22 °F ... +140 °F

Mechanical Data

Version	With connection chamber
Degree of protection (IP) (IEC 60529)	Reverse side IP65, front side IP66
Enclosure material	Polyamide
Silicone-free	Yes
Conductor length	3 m
Conductor length, inches	118.11 in
Connection cross-section	0,75 mm ²
Type of connection cable	H05VV-F2X0.75 GY
Packaging unit	1
Weight	635 g
Weight	1.4 lb

Mounting / Installation

Tightening torque	1.2 Nm
Tightening torque lbf in	10.62 lbf in
Connection	Plug-in connection, connection cable

Components

Entry 1	1 x 8161/7-M16-0902
Entry 1 type	Polyamide cable gland, black
Entry 1	M16 x 1.5
Entry 1 terminal area	2 – 9 mm
Entry 1 clamping range, inch	0.08 – 0.35 in

8013/313-al-3 UL Art. No. 216425

Dimensional Drawings (All Dimensions in mm [inches]) – Subject to Alterations

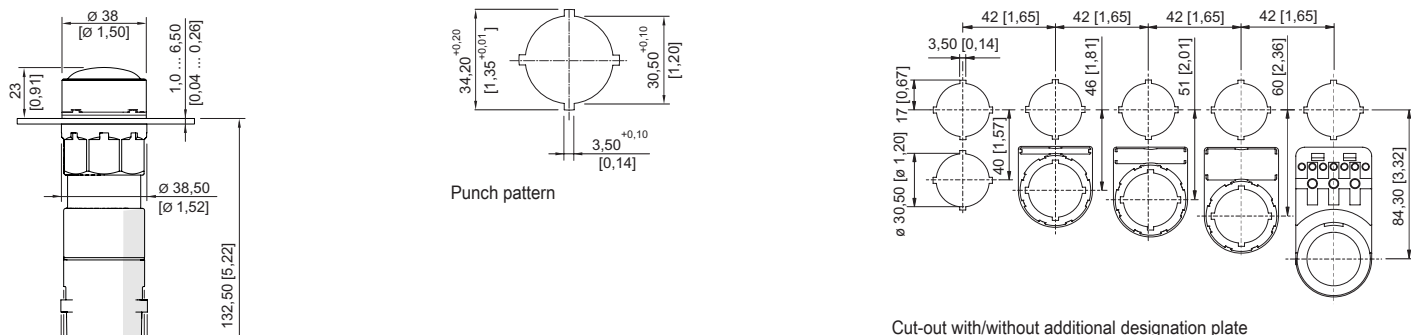

8013/3.1, 8013/3.3 indicator lamp with connection chamber

Spare Parts



Lens		Art. No.
	red	155842
	yellow	155834
	green	155852
	blue	155860
	white	155824
Closing part		Art. No.
	8602C3-733-B for closing unused holes in cover, dia. 30.5 mm, NBR	244306
	8602C3-733-S for closing unused holes in cover, dia. 30.5 mm, silicone	244307
Insert discs for label holder		Art. No.
	One-line Plain Material: PVC Colour: White Self-adhesive	238271
	Two-line Plain Material: PVC Colour: White Self-adhesive	238272
	Three-line Plain Material: PVC Colour: White Self-adhesive	238273

Control and signalling devices

LED indicator lamp for panel mounting



8013/313-al-3 UL Art. No. 216425

Label holder	Art. No.	
	Label holder, size 1, without insert disc Labelling: 1-line can be installed in dia. 30.5 mm drilled holes for actuators	155632
	Label holder, size 2, without insert disc Labelling: 1- or 2-line can be installed in dia. 30.5 mm drilled holes for actuators	155687
	Label holder, size 3, without insert disc Labelling: 1-, 2- or 3-line can be installed in dia. 30.5 mm drilled holes for actuators	155844

We reserve the right to make alterations to the technical data, dimensions, weights, designs and products available without notice. The illustrations cannot be considered binding.