

8510/111-02-209-050 Art. No. 217506



- Type-tested standard components
- Corrosion-resistant enclosure material

MY R. STAHL 8510A



The R. STAHL Series 8510 relay module provides cost-effective overload protection for motors. It is available in various versions and can contain up to 4 relays, each with different contact types. It can be fitted in Ex e enclosures using an anti-vibration screw connection, easily accessible terminals simplify installation.

### Technical Data

#### Explosion Protection

Application range (zones)	1 2
IECEX gas certificate	IECEX BVS 07.0029U
IECEX gas explosion protection	Ex db eb IIC
IECEX firedamp certificate	IECEX BVS 07.0029U
IECEX firedamp protection	Ex de I
ATEX gas certificate	DMT 00 ATEX E 073 U
ATEX gas explosion protection	Ex II 2 G Ex db eb IIC
ATEX firedamp certificate	DMT 00 ATEX E 073 U
ATEX firedamp protection	Ex I M2 Ex de I
Certificates	ATEX (BVS), Brazil (ULB), China (CQST), IECEX (BVS)

#### Electrical Data

Rated actuating voltage	230 V AC
Switching capacity	2 W
Frequency Hz (for AC)	60 50
Type of voltage	AC
Auxiliary contacts	2 change-over contact

#### Ambient Conditions

Ambient temperature	-20 °C ... +60 °C
---------------------	-------------------

#### Mechanical Data

Degree of protection (IP)	IP20
Enclosure material	Epoxy resin
Connection cross-section	1.5 mm <sup>2</sup>
Connection cross section min.	0.75 mm <sup>2</sup>
Max. connection cross section, solid	2,5 mm <sup>2</sup>

8510/111-02-209-050 Art. No. 217506

### Mechanical Data

Max. connection cross-section, finely stranded	1,5 mm <sup>2</sup>
Type of connection cable	Finely stranded Solid
Width	48 mm
Height	130 mm
Depth	110.5 mm
Weight	1.2 kg
Weight	2.65 lb

### Technical Drawings – Subject to Alterations

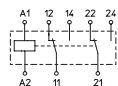

### Dimensional Drawings (All Dimensions in mm [inches]) – Subject to Alterations

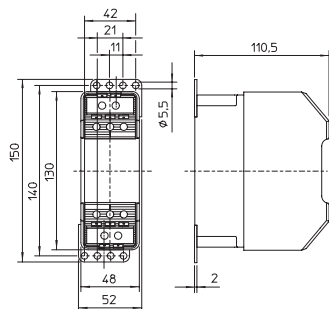

8510/111

We reserve the right to make alterations to the technical data, dimensions, weights, designs and products available without notice. The illustrations cannot be considered binding.