

Isolators

Loop-powered binary output

Ex i field circuit

9176/20-15-00s Art. No. 222180



- Suitable for solenoid valves and signalling devices
- Two-channel variants reduce the amount of space required
- No need for a separate auxiliary power supply

MY R. STAHL 9176A



The Series 9176 binary outputs transmit binary signals for the intrinsically safe operation of Ex i solenoid valves, indicator lamps and horns. The devices do not require a separate auxiliary power supply as they are powered by the control circuit. The intrinsically safe outputs are galvanically separated from the inputs. The two-channel variants are characterised by galvanically separated channels.

Technical Data

Explosion Protection

Application range (zones)	2
Ex interface zone	0, 1, 2, 20, 21, 22
IECEX gas certificate	IECEX BVS 13.0012 X
IECEX gas explosion protection	Ex nA [ia Ga] IIC T4 Gc
IECEX dust certificate	IECEX BVS 13.0012 X
IECEX dust explosion protection	[Ex ia Da] IIIC
ATEX gas certificate	BVS 04 ATEX E 075 X
ATEX gas explosion protection	⊕ II 3 (1) G Ex nA [ia Ga] IIC T4 Gc
ATEX dust certificate	BVS 04 ATEX E 075 X
ATEX dust explosion protection	⊕ II (1) D [Ex ia Da] IIIC
FMus certificate	FM16US0122X
cFM certificate	FM16CA0067X
Marking cFMus	Class I, Div. 2, Groups A,B,C,D; Class I, Zone 2, Group IIC AIS Class I,II,III, Div. 1, Groups A,B,C,D,E,F,G; Class I, Zone 0, [AEx/Ex ia] IIC T4 Mounting vert. at Ta = 70°C , or horizontal Ta = 60°C See Doc. 91 766 01 31 1
Certificates	ATEX (BVS), Brazil (ULB), Canada (FM), IECEX (BVS), SIL (exida), USA (FM)
Ship approval	CCS, EU RO MR (DNV)
Declaration of conformity	ATEX (EUK), China (CCC)

Safety Data

Max. voltage U_o	27.6 V
Max. current I_o (Ex ia)	86.5 mA
Max. current I_o (Ex ib)	44 mA
Max. power P_o	596 mW

Safety Data

Max. permissible external capacity C_o for IIC	0.085 μ F
Max. permissible external inductance L_o for IIC	1.8 mH
Max. permissible external capacity C_o for IIB	0.667 μ F
Max. permissible external inductance L_o for IIB	17 mH
Internal capacitance	1.1 nF
Internal capacitance	1.1 nF
Internal inductance	Negligible
Max. voltage U_o parallel	27.6 V
Max. power P_o parallel	1192 mW
Max. current I_o (Ex ia) paral.	173 mA
Max. current I_o (Ex ib) paral.	88 mA
Internal capacitance parallel	2.2 nF
Internal inductance parallel	negligible
Safety-related max. voltage	253 V
Intrinsically safe limiting values inductance L_o /capacitance C_o	Max. connectable inductance L_o /capacitance C_o 2 parallel channels
IIC	L_o [mH] C_o [μ F]
IIB	L_o [mH] C_o [μ F]
IIIC	L_o [mH] C_o [μ F]

Electrical Data

Number of channels	2
Internal resistance R_i	320 Ω

Auxiliary Power

Auxiliary power	without
Auxiliary power consumption	0.5 W + (I_a x 37 mW/mA)
Polarity reversal protection	Yes

Galvanic Isolation

Test voltage as per standard	EN IEC 60079-11
Ex i input to Ex i input	500 V AC
Test voltage as per standard	EN 50178
Input to input	350 V AC

Input

Input	In accordance with EN 61131-2
Input voltage for ON	18 – 31.2 V
Input voltage for OFF	0 – 5 V
Control Power P_E	0.5 W+ (I_a x 37 mW/mA) (with I_a = max. required output current)

Output

Output open-circuit voltage U_a	25 V
-----------------------------------	------

Output

Max. output current $I_{a \max}$	29 mA
Max. output current I_a note	Parallel channels: 58 mA
Internal resistance R_i note	320 Ω /parallel: 160 Ω
Output residual ripple	< 100 mV
Output switching frequency	≤ 10 Hz
Switching delay ON/OFF	≤ 50 ms
Switching delay OFF/ON	≤ 18 ms
Switching state indication	Yellow "OUT"; LED

9176/0-15-00 output characteristic

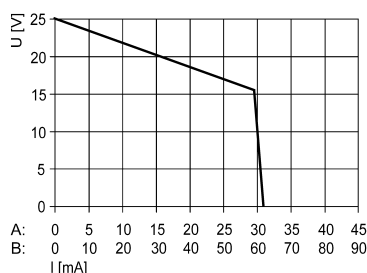

At U_N ; -20 to +60 °C

X axis (I [mA])

A: Characteristic curve for each channel

B: Characteristic curve for channel 1, parallel channel 2 (only types 9176/20-...-...)

Ambient Conditions

Ambient temperature	-20 °C ... 70 °C (Single device) -20 °C ... 60 °C (Group assembly)
Ambient temperature	-4 °F ... +158 °F (Single device) -4 °F ... +140 °F (Group assembly)
Note	Installation conditions influence the ambient temperature. Please observe the "Cabinet installation guide".
Storage temperature	-40 °C ... 80 °C
Storage temperature	-40 °F ... +176 °F
Maximum relative humidity	95%
Use at the height of	< 2000 m
Electromagnetic compatibility	Tested to the following standards and regulations: EN 61326-1 For use in industrial areas; NAMUR NE 21

Mechanical Data

Degree of protection (IP)	IP30
Degree of protection (IP) terminals	IP20
Fire resistance (UL 94)	V0
Enclosure material	Polyamide
Min. rigid conductor cross section	0.2 mm ²
Max. rigid conductor cross section	2.5 mm ²
Min. flexible conductor cross section	0.2 mm ²
Max. flexible conductor cross section	2.5 mm ²
Width	17.6 mm
Width	17.6 mm
Width, inches	0.69 in
Height	114.5 mm
Height	114.5 mm
Height in inches	4.51 in
Length	108 mm
Length in inches	4.25 in

Isolators

Loop-powered binary output

Ex i field circuit

9176/20-15-00s Art. No. 222180



Mechanical Data

Weight	185 g
--------	-------

Mounting / Installation

Mounting type	DIN rail NS35/15, NS35/7.5
Grid dimension	17.6 mm
Mounting orientation	Vertical Horizontal
Connection type	Screw terminal
Connection cross-section AWG	24 ... 14

Technical Drawings – Subject to Alterations

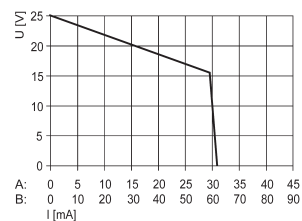

9176/0-15-00 output characteristic

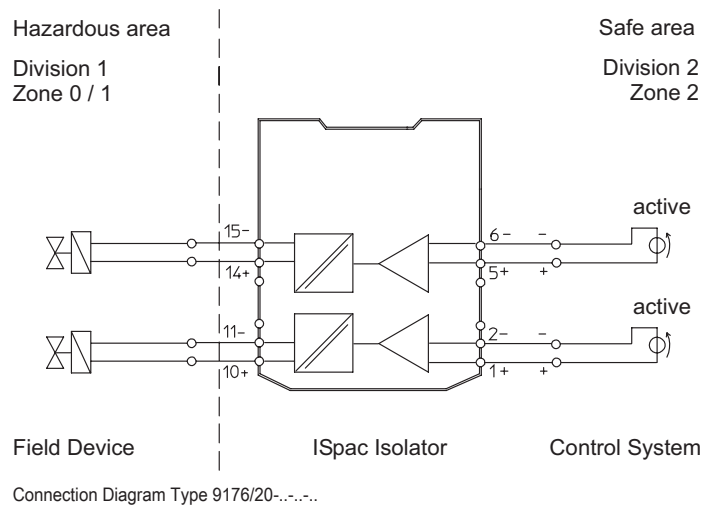

Accessories

Ex i/Ex e relay module for Zone 1



The Ex i/Ex e relay module is used for the galvanically isolated switching of intrinsically safe (Ex i) and non-Ex i (Ex e) electrical circuits.

Coil circuit: Ex i or non-Ex i (Ex e)

Contact circuit: Ex i or non-Ex i (Ex e)

Thanks to the integrated safeguarding for the contact and coil circuit, additional safeguarding is not necessary.

Usable with the following ISpac isolators: 9175/10-16-11, 9175/20-16-11, 9176/20-15-00, 9176/10-16-00, 9176/20-16-00, 9275/10-24-48-11, 9276/10-21-60-00, 9276/10-24-48-00

Usable with the following IS1+ modules: 9475/32-04-22, 9475/32-08-62, 9475/33-08-60

Art. No.

273000

Spare Parts

Screw terminal



3-pole plug, screw connector
thread: M3
stripping length: 7 mm
colour: green

Art. No.

112817





Isolators

Loop-powered binary output

Ex i field circuit

9176/20-15-00s Art. No. 222180

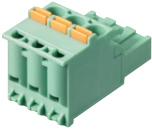

Screw terminal		Art. No.
	3-pole plug, screw connector thread: M3 stripping length: 7 mm colour: black	112816
	3-pole plug, screw connector thread: M3 stripping length: 7 mm colour: blue	112818
Spring clamp terminal		Art. No.
	3-pole plug with test tap, spring clamp connection stripping length: 10 mm colour: green	112825
	3-pole plug with test tap, spring clamp connection stripping length: 10 mm colour: black	112824
	3-pole plug with test tap, spring clamp connection stripping length: 10 mm colour: blue	112826

We reserve the right to make alterations to the technical data, dimensions, weights, designs and products available without notice. The illustrations cannot be considered binding.