

Lighting

Emergency luminaire For fluorescent lamps

GRP

6009/542-9617-1611-71 Art. No. 225725



- Can be used in Zones 1, 2, 21 and 22
- Two fluorescent lamps: 18 W and 36 W
- Weekly function test and annual emergency light duration test

MY R. STAHL 6009A



The 6009 series EXLUX emergency luminaire is suitable for use as safety lighting. It is lightweight and requires minimal maintenance. The battery is housed in the external enclosure and powers the emergency lighting for 1.5 or 3 hours. If one lamp is faulty, the luminaire switches to the working lamp. When the central lock is opened, the luminaire is always disconnected from the power supply at all poles.

Technical Data

Explosion Protection

Ex version	Yes
Application range (zones)	1 2 21 22
IECEX gas certificate	IECEX PTB 13.0059
IECEX gas explosion protection	Ex db eb mb IIC T4 Gb
IECEX dust certificate	IECEX PTB 13.0059
IECEX dust explosion protection	Ex tb IIIC T80 °C Db
ATEX gas certificate	PTB 13 ATEX 2015
ATEX gas explosion protection	Ex II 2 G Ex db eb mb IIC T4 Gb
ATEX dust certificate	PTB 13 ATEX 2015
ATEX dust explosion protection	Ex II 2 D Ex tb IIIC T80 °C Db
Certificates and approvals	ATEX IECEX ship approval (DNV GL)
Certificates	ATEX (PTB), IECEX (PTB)
Ship approval	DNV

Electrical Data

Rated operational voltage AC	220 ... 240 V
Battery version	NiCd battery, gas-tight
Battery operating voltage	6 V
Battery capacity	7 Ah
Self-test function	With (standard)
Frequency range	50 – 60 Hz

Lighting Data

Number of lamps	2
-----------------	---

Lighting

Emergency luminaire For fluorescent lamps

GRP

6009/542-9617-1611-71 Art. No. 225725



Lighting Data

Lamp wattage	36 W
Lamp	G13 lamp base
Luminaire efficacy	0 lm/W
Luminous flux	0 lm
Operating time	1.5 / 3h emergency lighting operation
Emergency light mode	Continuous light Or stand-by light
Emergency light output	30% – 3 h 60% – 1.5 h

Ambient Conditions

Ambient temperature	-30 °C ... +50 °C Note: Through wiring Max. 3x16 A -30 °C ... +55 °C Note: Through wiring 2 Max. 3x8 A
---------------------	---

Mechanical Data

Version	Standard
IP degree of protection (IEC 60598)	IP66 / IP67
Class	I (with inner PE connection)
Enclosure material	Polyester resin, Glass fibre reinforced
Enclosure colour	Light grey (RAL 7035)
Sealing material	Silicone
Silicone-free content	Contains silicone
Translucent cover material	Polycarbonate
Installed terminal strip	PE + N + L1 + L2 + L3 + L´
Max. solid connection terminals	6 mm ²
Max. finely stranded connection terminals	4 mm ²
Lighting lock	Central lock , For box spanner actuation
Type of connection cable	Finely stranded Solid
Size	4
Width	183.5 mm
Height	125 mm
Length	1467 mm
Impact strength (IEC 62262)	IK10
Weight	9.65 kg
Weight	21.27 lb
Disconnection of the luminaire	All-pole disconnection

Components

Threaded plate	2x plastic
Ballast	6043/792-201
Through wiring	With 6 conductors 2.5 mm ²
Battery-Version	NiCd battery, gas-tight
Drilled holes	3 x M25
Cable glands and entries	2 x M25 Ø 7 ...
Material cable gland	Polyamide, black
Stopping plugs	2 x M25 x 1.5
Stopping plug material	Polyamide, black
Accessories	Provided

Lighting

Emergency luminaire For fluorescent lamps

GRP

6009/542-9617-1611-71 Art. No. 225725



Dimensional Drawings (All Dimensions in mm [inches]) – Subject to Alterations

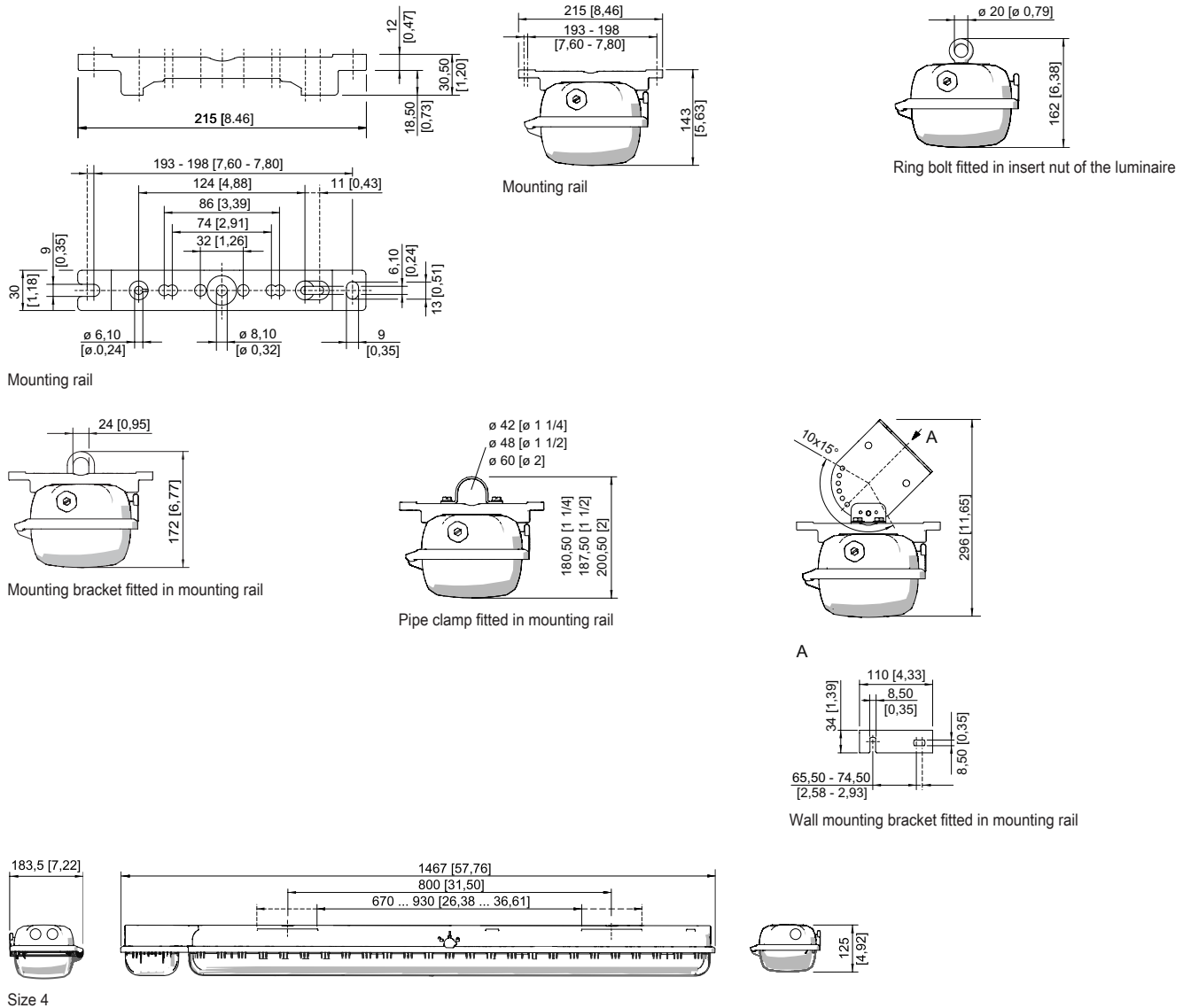

Accessories

Box spanner

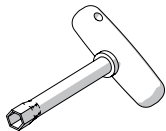

M8 / A/F 13;
For actuating the central lock

Art. No.

222430

Breather

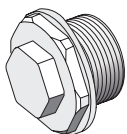

Thread: M25 x 1.5 (1 piece); for installation in light fittings; made from stainless steel; without jam nut

Art. No.

296608

Lighting

Emergency luminaire For fluorescent lamps

GRP

6009/542-9617-1611-71 Art. No. 225725

STAHL

Ceiling and wall mounting bracket

Art. No.

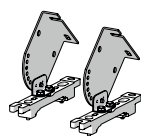

mounted on a mounting rail for a variable mounting distance; Material: stainless steel; Lamp can be swiveled in steps of 15°; 1 pair

222827

Cover

Art. No.

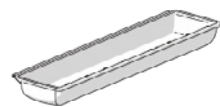

For size 4 luminaires (diffuse), when used on an emergency luminaire with individual power supply, the visibility of the display LED may be restricted

276670

Holder for translucent cover

Art. No.



The fall prevention system for the light fitting cover prevents the light fitting cover from falling accidentally when the light fitting is opened.

226791

Mounting bracket

Art. No.

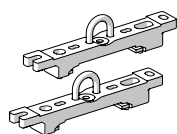

mounting clamp mounted on a mounting rail for a variable mounting distance; 1 pair

222456

Mounting rail

Art. No.

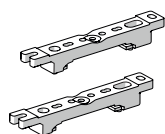

for a variable mounting distance; 1 pair

222826

Pipe clamp

Art. No.

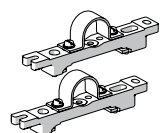

R 1 1/2"; with mounting rail for a variable mounting distance; material: stainless steel; 1 pair

222459

R 1 1/4"; with mounting rail for a variable mounting distance; Material: stainless steel; 1 pair

222458

R 2"; with mounting rail for a variable mounting distance; Material: stainless steel; 1 pair

222460

Pole mounting sleeve

Art. No.



for the subsequent mounting on lights size 2 and size 4, completely with assembly parts (for pipe diameter 42 mm)

227512

Ring bolt

Art. No.



M8, direct mounting in insert nuts; 1 pair

115736

Spare Parts

Battery set

Art. No.

Lighting

Emergency luminaire For fluorescent lamps

GRP

6009/542-9617-1611-71 Art. No. 225725

STAHL

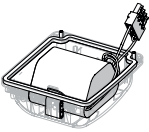
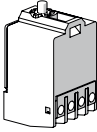
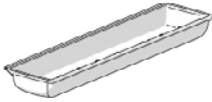
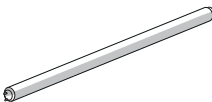
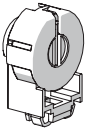
	Battery cover with built-in battery. Gas-tight NiCd battery; 7 Ah / 6 V	223532
Contact element		Art. No.
	8080/1-3-L 2 NC contact element	132527
Cover		Art. No.
	for luminaire size 4	222428
Fluorescent lamp		Art. No.
	36 W, 3350 lm	108951
Lamp holder		Art. No.
	G13 Ex e lamp holder for light fittings with T8 fluorescent lamps for use in Zone 1	117252

We reserve the right to make alterations to the technical data, dimensions, weights, designs and products available without notice. The illustrations cannot be considered binding.