

8602C3-728-B-90X-E08 Art. No. 227211



- Pushbutton, mushroom pushbutton, mushroom stay-put button with key lock, mushroom stay-put button, twin pushbutton and illuminated pushbutton, rotary actuator, key-operated switch, potentiometer bezel and indicator lamp bezel
- One axial actuator can actuate up to four Series 8082 contact elements
- Key-operated switches and rotary switches codable at any time as "latching/spring return" or "key not removable"

MY R. STAHL 8602A



Thanks to their special technical features, the actuators from the 8602/3 series can withstand the most extreme conditions. In addition to the application option for use in ambient temperatures from -60 °C to +70 °C, the IP degree of protection, IP66, is maintained in accordance with EN 60529. It is also possible to actuate up to four contact elements from the 8082 series with a single axial actuator from the 8602/3 series.

The coding option of the key switches and rotary switches is innovative and one-of-a-kind. Integrated coding allows you to adjust the "latching/spring return" and/or "key not removable" functions at any time without additional accessories. A versatile set of accessories consisting of label holders and locking devices is available.

Technical Data

Explosion Protection

Application range (zones)	1, 2, 21, 22
IECEX gas certificate	IECEX PTB 13.0047U
IECEX gas certificate	IECEX PTB 13.0047U
IECEX gas explosion protection	Ex eb IIC Gb
IECEX dust certificate	IECEX PTB 13.0047 U
IECEX dust explosion protection	Ex tb IIIC Db
ATEX gas certificate	PTB 13 ATEX 1019 U
ATEX gas certificate	PTB 13 ATEX 1019 U
ATEX gas explosion protection	Ex II 2 G Ex eb IIC Gb
ATEX dust certificate	PTB 13 ATEX 1019 U
ATEX dust explosion protection	Ex II 2 D Ex tb IIIC Db
UL gas certificate	E182378 V4 S2
Inmetro gas certificate	UL-BR 14.0380U
Inmetro dust certificate	UL-BR 14.0380U
Certificates	ATEX (PTB), Brazil (ULB), Canada / USA (UL), Canada (UL), IECEX (PTB), India (PESO), Korea (KGS)

Ambient Conditions

Ambient temperature	-20 °C ... 60 °C
Ambient temperature	-4 °F ... +140 °F
Storage temperature	-25 °C ... 60 °C
Storage temperature	-13 °F ... +140 °F
Use at the height of	< 2000 m
Max. operating altitude	2000 m

Installation equipment

Large rotary actuator Increased



8602C3-728-B-90X-E08 Art. No. 227211

Ambient Conditions

Degree of contamination	3
-------------------------	---

Mechanical Data

Version	increased height
Degree of protection (IP)	IP66
Note on degree of protection	According to IEC/EN 60529
Enclosure material	Polyamide
Silicone-free	Yes
Assembly	728
Diameter	65 mm
Service life, min.	10 ⁵ actuations
Impact strength (IEC 60079)	7 J
Impact strength (IEC 62262)	min. IK08
Handle colour	Black
Protective collar colour	Black
Fastening	Thread type
Designation plate	0/OFF – I/ON
Seal	Standard
Lockable in	90°
Packaging unit	1
Weight	40 g
Weight	0.09 lb
Description note	Lockable option (max. 3 times) can be determined using the enclosed closing parts. Lockable handle position: 90°. In the unmounted assemblies, the standard label is 0/OFF-I/ON and the long coupling part is enclosed. Other labels must be ordered separately.

Mounting / Installation

Mounting type	Not installed
Tightening torque	3 Nm
Tightening torque lbf in	26.55 lbf in

8602C3-728-B-90X-E08 Art. No. 227211

Technical Drawings – Subject to Alterations

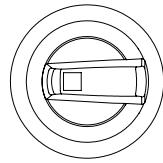
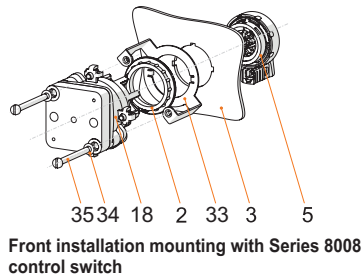

Explanation of position display:
 Standard switch, lockable in 0/OFF
 Position of handle 90°

Key

- 2 = jam nut (order no. 205592)
- 3 = installation wall (wall thickness max. 2 mm [0.0787 inch])
- 5 = 8302/3 actuator with seal (4)
- 18 = 8008/2- control switch
- 33 = front installation 8602/3 adaptor for type 8008/2
- 34 = M4 disc
- 35 = M4x screw

Dimensional Drawings (All Dimensions in mm [inches]) – Subject to Alterations

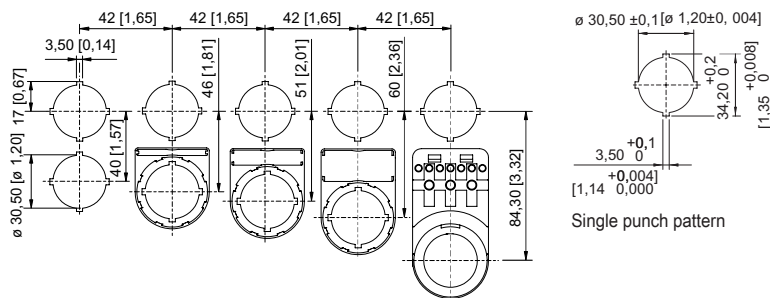

Cut-out with/without additional designation plate

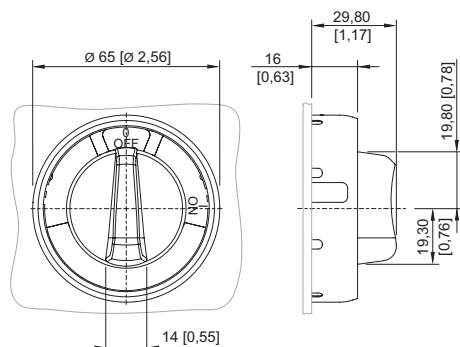

8602/3-728 rotary actuator, black handle, red protective collar
 8602/3-729 rotary actuator, red handle, black protective collar
 Actuator with radial actuation

Accessories

Cylinder lock

Art. No.

Installation equipment

Large rotary actuator Increased



8602C3-728-B-90X-E08 Art. No. 227211

	for closing (bracket Ø 3)	107115
--	---------------------------	--------

Spare Parts

Labels for large BG 728, BG 729, BG 730, BG 731 rotary actuator

Art. No.



	Dia. 58 0/OFF I/ON	227004
	Dia. 58 0 OPERATION I	227005
	Dia. 58 0 I II	227006
	Dia. 58 I 0 II	227007
	Dia. 58 I II	227008
	Dia. 58 0 I	227009
	Dia. 58 I 0 I 0	227010
	Dia. 58 MANUAL 0 AUTO	227011
	Dia. 58 0/OFF 0 I/ON	227012
	Dia. 58, yellow 0/OFF I/ON	227013

Installation equipment

Large rotary actuator Increased



8602C3-728-B-90X-E08 Art. No. 227211

	Dia. 58 0 I (90°)	273760
	Dia. 58 Plain	227014
Special key		Art. No.
	for tightening plastic locking nut	169101
Adaptor for front installation		Art. No.
	8602/3 front installation for control switch of Series 8008	260081

We reserve the right to make alterations to the technical data, dimensions, weights, designs and products available without notice. The illustrations cannot be considered binding.