

Lighting

Linear luminaire For fluorescent lamps

GRP

6401/562-8508-15-232 Art. No. 239557



- Can be used in Zone 2, 21 and 22
- Explosion-protected linear luminaire with two fluorescent lamps: 18 W, 36 W and 58 W
- Extremely robust: Impact strength rating of IK10

MY R. STAHL 6401A



The 6401 EXLUX luminaire is suited to normal indoor and outdoor lighting applications. In no time at all and with very little effort, using the accessories it can be fitted to the wall, ceiling or a pole, or alternatively, it can be suspended. The practical central lock is available with an optional switching element that disconnects the power supply at all poles when the plastic enclosure is opened. Lightweight yet strong: The high-quality workmanship makes this luminaire robust and minimises maintenance requirements.

Technical Data

Explosion Protection

Ex version	Yes
Application range (zones)	2 21 22
IECEX gas certificate	IECEX PTB 14.0035
IECEX gas explosion protection	Ex ec IIC T4 Gc
IECEX dust certificate	IECEX PTB 14.0035
IECEX dust explosion protection	Ex tb / tc IIIC T80 °C Db
ATEX gas certificate	PTB 14 ATEX 2017
ATEX gas explosion protection	⊕ II 3 G Ex ec IIC T4 Gc
ATEX dust certificate	PTB 14 ATEX 2016
ATEX dust explosion protection	⊕ II 2 D Ex tb / tc IIIC T80 °C Db
Certificates and approvals	ATEX IECEX
Certificates	ATEX (PTB), IECEX (PTB)

Electrical Data

Rated operational voltage AC	220 ... 240 V
Rated operational voltage DC	220 ... 240 V
Frequency range	50 – 60 Hz

Lighting Data

Number of lamps	2
Lamp wattage	58 W
Lamp	G13 lamp base
Luminaire efficacy	0 lm/W
Luminous flux	0 lm

Lighting

Linear luminaire For fluorescent lamps

GRP

6401/562-8508-15-232 Art. No. 239557



Ambient Conditions

Ambient temperature	-20 °C ... +50 °C (T80 °C) Note: Through wiring Max. 3x16 A (T80 °C)
---------------------	--

Mechanical Data

Version	Standard
IP degree of protection (IEC 60598)	IP66
Class	I (with inner PE connection)
Enclosure material	Polyester resin, Glass fibre reinforced
Enclosure colour	Light grey (RAL 7035)
Sealing material	Silicone
Silicone-free content	Contains silicone
Translucent cover material	Polycarbonate
Installed terminal strip	PE + N + L1 + L2 + L3
Max. solid connection terminals	6 mm ²
Max. finely stranded connection terminals	4 mm ²
Type of connection cable	Finely stranded Solid Stranded
Size	6
Width	184 mm
Height	125 mm
Length	1610 mm
Impact strength (IEC 62262)	IK10
Weight	7.9 kg
Weight	17.42 lb
Disconnection of the luminaire	No

Components

Threaded plate	2x SS430 stainless steel
Ballast	ELXe
Through wiring	With 5 conductors 2.5 mm ²
Drilled holes	3 x M20
Cable glands and entries	Can be ordered as accessories
Stopping plugs	Can be ordered as accessories
Accessories	without

Light Distribution Curves

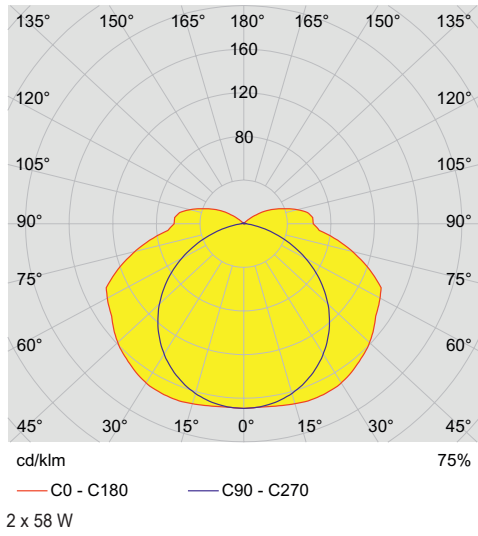

Dimensional Drawings (All Dimensions in mm [inches]) – Subject to Alterations

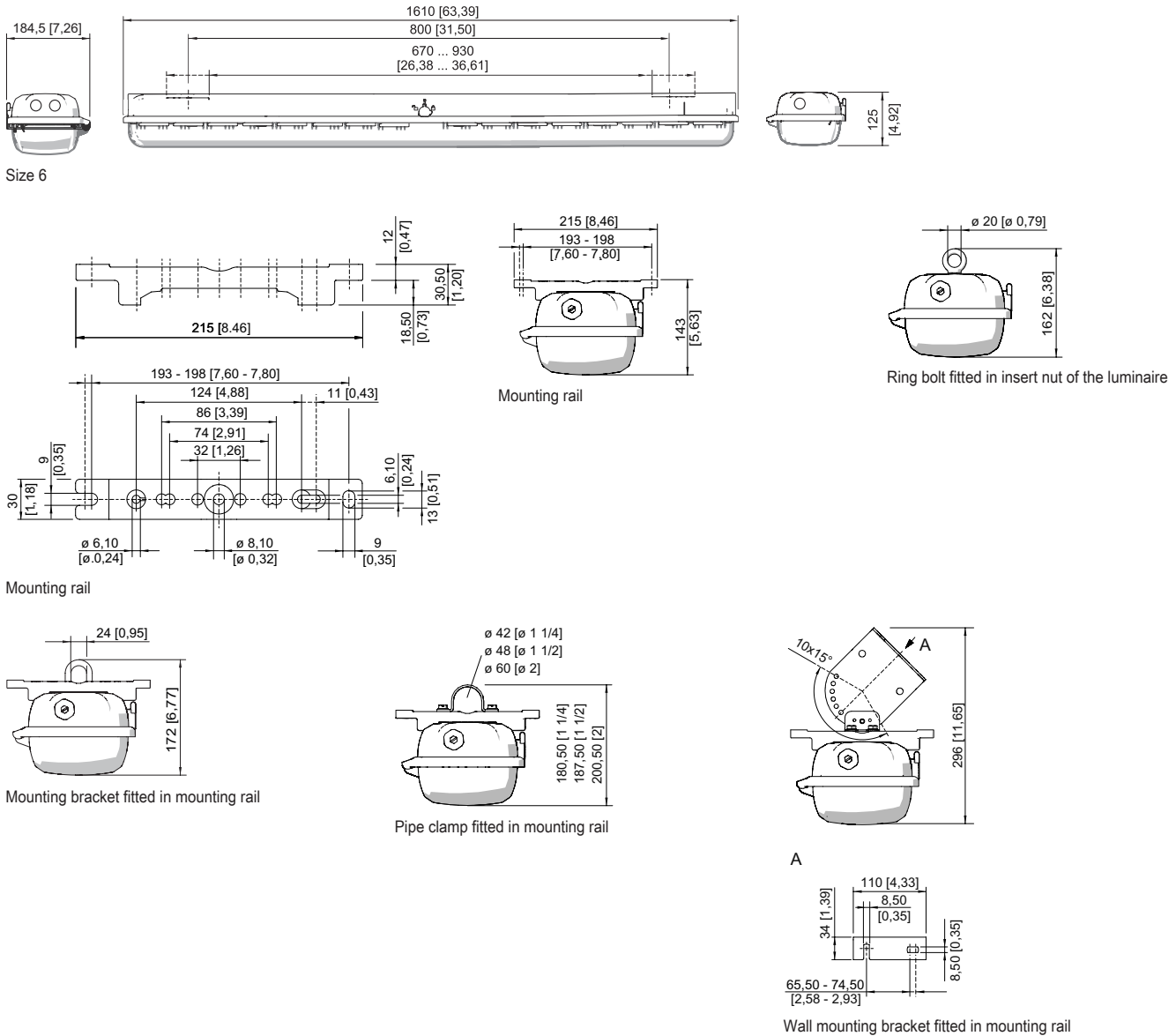

Lighting

Linear luminaire For fluorescent lamps

GRP

6401/562-8508-15-232 Art. No. 239557



Accessories

Box spanner

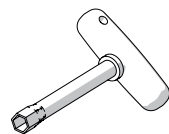

M8 / A/F 13;
For actuating the central lock

Art. No.

222430

Breather

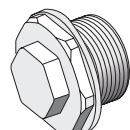

Thread: M25 x 1.5 (1 piece); for installation in light fittings; made from stainless steel; without jam nut

Art. No.

296608

Ceiling and wall mounting bracket

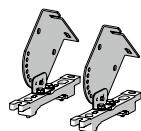

mounted on a mounting rail for a variable mounting distance; Material: stainless steel; Lamp can be swiveled in steps of 15°; 1 pair

Art. No.

222827

Holder for translucent cover



The fall prevention system for the light fitting cover prevents the light fitting cover from falling accidentally when the light fitting is opened.

Art. No.

226791

Mounting bracket

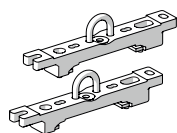

mounting clamp mounted on a mounting rail for a variable mounting distance; 1 pair

Art. No.

222456

Mounting rail

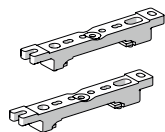

for a variable mounting distance; 1 pair

Art. No.

222826

Pipe clamp

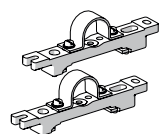

R 1 1/2"; with mounting rail for a variable mounting distance; material: stainless steel; 1 pair

R 1 1/4"; with mounting rail for a variable mounting distance; Material: stainless steel; 1 pair

R 2"; with mounting rail for a variable mounting distance; Material: stainless steel; 1 pair

Art. No.

222459

222458

222460

Pole mounting sleeve



for the subsequent mounting on lights size 2 and size 4, completely with assembly parts (for pipe diameter 42 mm)

Art. No.

227512

Lighting

Linear luminaire For fluorescent lamps

GRP

6401/562-8508-15-232 Art. No. 239557



Ring bolt

Art. No.



M8, direct mounting in insert nuts; 1 pair

115736

Spare Parts

Art. No.

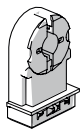

G13 lamp holder for light fittings with T8 fluorescent lamps for use in Zone 2 and for industrial applications (x 100 units)

107275

Contact element

Art. No.

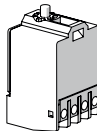

8080/1-3-L 2 NC contact element

132527

Cover

Art. No.

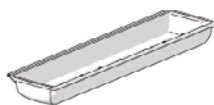

for luminaire size 6

222429

Fluorescent lamp

Art. No.

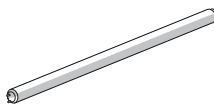

58 W, 5200 lm

108950

We reserve the right to make alterations to the technical data, dimensions, weights, designs and products available without notice. The illustrations cannot be considered binding.