

# Lighting

## Emergency luminaire For fluorescent lamps

GRP

6409/542-9007-1611-7 Art. No. 240878



- Can be used in Zones 2, 21 and 22
- Weekly function test and annual emergency light duration test

MY R. STAHL 6409A



The 6409 Series EXLUX emergency luminaire is suitable for use as safety lighting. It is lightweight and requires minimal maintenance. The external battery powers the emergency lighting for 1.5 or 3 hours. If one lamp is faulty, the luminaire switches to the working lamp. When the luminaire or battery case is opened, the battery circuit is disconnected. The robust plastic enclosure of the luminaire is easy to open thanks to the practical central lock.

### Technical Data

#### Explosion Protection

Ex version	Yes
Application range (zones)	2 21 22
IECEX gas certificate	IECEX PTB 14.0043
IECEX gas explosion protection	Ex db ec mb IIC T4 Gc
IECEX dust certificate	IECEX PTB 14.0043
IECEX dust explosion protection	Ex tc / tb IIIC T80 °C Dc
ATEX gas certificate	PTB 14 ATEX 2022
ATEX gas explosion protection	⊕ II 3 G Ex db ec mb IIC T4 Gc
ATEX dust certificate	PTB 14 ATEX 2022
ATEX dust explosion protection	⊕ II 3 D Ex tc / tb IIIC T80 °C Dc
Certificates and approvals	ATEX IECEX
Certificates	ATEX (PTB), IECEX (PTB)

#### Electrical Data

Rated operational voltage AC	220 ... 240 V
Battery version	NiCd battery, gas-tight
Battery operating voltage	6 V
Battery capacity	7 Ah
Self-test function	With (standard)
Frequency range	50 – 60 Hz

#### Lighting Data

Number of lamps	2
Lamp wattage	36 W
Lamp	G13 lamp base

# Lighting

## Emergency luminaire For fluorescent lamps

GRP

6409/542-9007-1611-7 Art. No. 240878



### Lighting Data

Luminaire efficacy	0 lm/W
Luminous flux	0 lm
Operating time	1.5 / 3h emergency lighting operation
Emergency light mode	Continuous light Or stand-by light
Emergency light output	30% – 3 h 60% – 1.5 h

### Ambient Conditions

Ambient temperature	-30 °C ... +55 °C
---------------------	-------------------

### Mechanical Data

Version	Standard
IP degree of protection (IEC 60598)	IP66 / IP67
Class	I (with inner PE connection)
Enclosure material	Polyester resin, Glass fibre reinforced
Enclosure colour	Light grey (RAL 7035)
Sealing material	Silicone
Silicone-free content	Contains silicone
Translucent cover material	Polycarbonate
Installed terminal strip	PE + N + L1 + L2 + L3 + L´
Max. solid connection terminals	6 mm <sup>2</sup>
Max. finely stranded connection terminals	4 mm <sup>2</sup>
Type of connection cable	Finely stranded Solid
Size	4
Width	183.5 mm
Height	125 mm
Length	1467 mm
Impact strength (IEC 62262)	IK10
Weight	9.5 kg
Weight	20.94 lb
Disconnection of the luminaire	Only battery

### Components

Threaded plate	2x plastic
Ballast	6043/792-201
Through wiring	without
Battery-Version	NiCd battery, gas-tight
Drilled holes	3 x M25
Cable glands and entries	2 x M25 Ø 7 ...
Material cable gland	Polyamide, black
Stopping plugs	2 x M25 x 1.5
Stopping plug material	Polyamide, black
Accessories	Provided

# Lighting

## Emergency luminaire For fluorescent lamps

### GRP

6409/542-9007-1611-7 Art. No. 240878



#### Dimensional Drawings (All Dimensions in mm [inches]) – Subject to Alterations

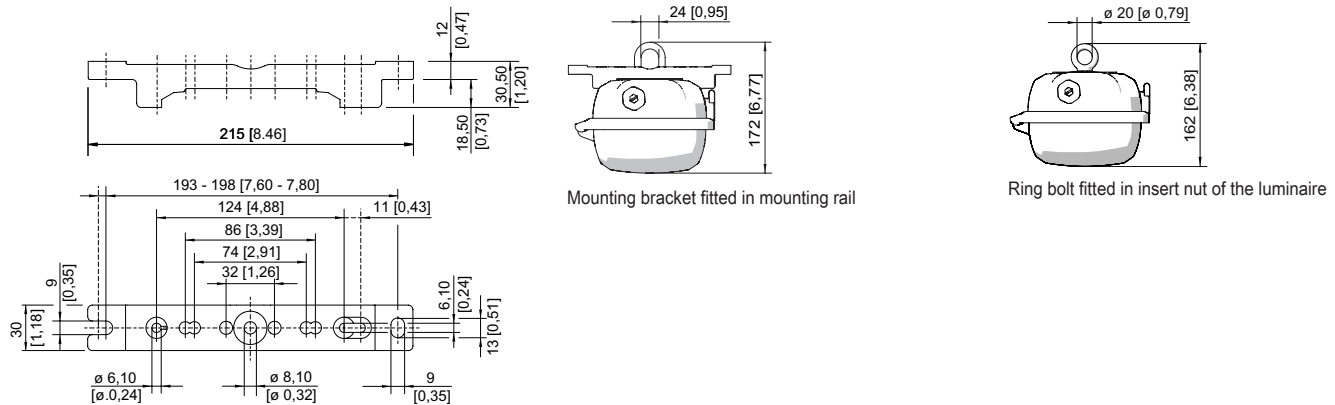

Mounting rail

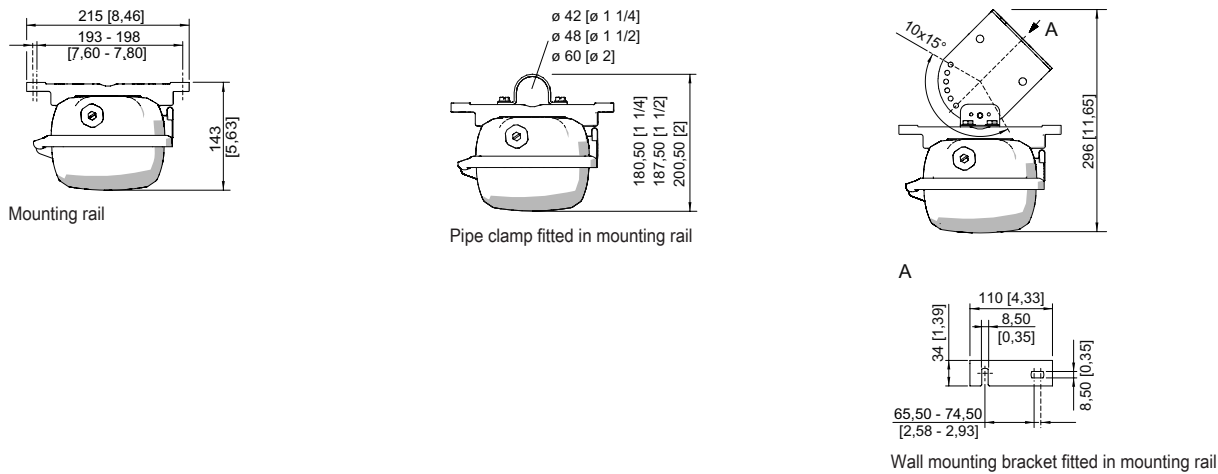

Mounting rail

Pipe clamp fitted in mounting rail

A

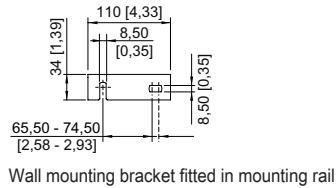

Wall mounting bracket fitted in mounting rail

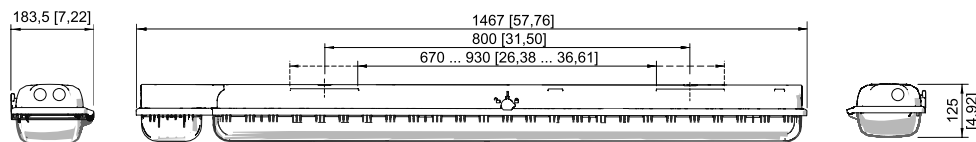

Size 4

## Accessories

### Box spanner

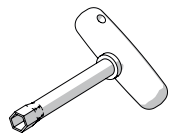

M8 / A/F 13;  
For actuating the central lock

Art. No.

222430

### Breather

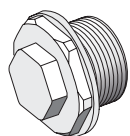

Thread: M25 x 1.5 (1 piece); for installation in light fittings; made from stainless steel; without jam nut

Art. No.

296608

# Lighting

Emergency luminaire For fluorescent lamps

GRP

6409/542-9007-1611-7 Art. No. 240878

STAHL

## Ceiling and wall mounting bracket

Art. No.

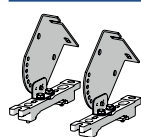

mounted on a mounting rail for a variable mounting distance; Material: stainless steel; Lamp can be swiveled in steps of 15°; 1 pair

222827

## Cover

Art. No.

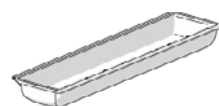

For size 4 luminaires (diffuse), when used on an emergency luminaire with individual power supply, the visibility of the display LED may be restricted

276670

## Holder for translucent cover

Art. No.



The fall prevention system for the light fitting cover prevents the light fitting cover from falling accidentally when the light fitting is opened.

226791

## Mounting bracket

Art. No.

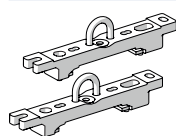

mounting clamp mounted on a mounting rail for a variable mounting distance; 1 pair

222456

## Mounting rail

Art. No.

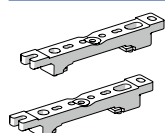

for a variable mounting distance; 1 pair

222826

## Pipe clamp

Art. No.

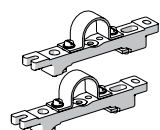

R 1 1/4"; with mounting rail for a variable mounting distance; Material: stainless steel; 1 pair

222458

R 2"; with mounting rail for a variable mounting distance; Material: stainless steel; 1 pair

222460

## Ring bolt

Art. No.



M8, direct mounting in insert nuts; 1 pair

115736

## Spare Parts

### Battery set

Art. No.

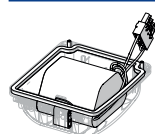

Battery cover with built-in battery. Gas-tight NiCd battery; 7 Ah / 6 V

223532

# Lighting

Emergency luminaire For fluorescent lamps

GRP

6409/542-9007-1611-7 Art. No. 240878



## Contact element

Art. No.

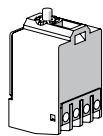

8080/1-3-L 2 NC contact element

132527

## Cover

Art. No.

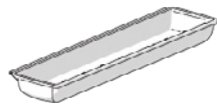

for luminaire size 4

222428

## Fluorescent lamp

Art. No.

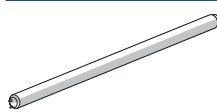

36 W, 3350 lm

108951

We reserve the right to make alterations to the technical data, dimensions, weights, designs and products available without notice. The illustrations cannot be considered binding.