

Lighting

Emergency luminaire For fluorescent lamps

GRP

6409/542-9607-1622-7 Art. No. 240895



- Can be used in Zones 2, 21 and 22
- Weekly function test and annual emergency light duration test

MY R. STAHL 6409A



The 6409 Series EXLUX emergency luminaire is suitable for use as safety lighting. It is lightweight and requires minimal maintenance. The external battery powers the emergency lighting for 1.5 or 3 hours. If one lamp is faulty, the luminaire switches to the working lamp. When the luminaire or battery case is opened, the battery circuit is disconnected. The robust plastic enclosure of the luminaire is easy to open thanks to the practical central lock.

Technical Data

Explosion Protection

| | |
|---------------------------------|-------------------------------------|
| Ex version | Yes |
| Application range (zones) | 2 21 22 |
| IECEX gas certificate | IECEX PTB 14.0043 |
| IECEX gas explosion protection | Ex db ec mb IIC T4 Gc |
| IECEX dust certificate | IECEX PTB 14.0043 |
| IECEX dust explosion protection | Ex tc / tb IIIC T80 °C Dc |
| ATEX gas certificate | PTB 14 ATEX 2022 |
| ATEX gas explosion protection | Ex II 3 G Ex db ec mb IIC T4 Gc |
| ATEX dust certificate | PTB 14 ATEX 2022 |
| ATEX dust explosion protection | Ex II 3 D Ex tc / tb IIIC T80 °C Dc |
| Certificates and approvals | ATEX IECEX |
| Certificates | ATEX (PTB), IECEX (PTB) |

Electrical Data

| | |
|------------------------------|-------------------------|
| Rated operational voltage AC | 220 ... 240 V |
| Battery version | NiCd battery, gas-tight |
| Battery operating voltage | 6 V |
| Battery capacity | 7 Ah |
| Self-test function | With (standard) |
| Frequency range | 50 – 60 Hz |

Lighting Data

| | |
|-----------------|---------------|
| Number of lamps | 2 |
| Lamp wattage | 36 W |
| Lamp | G13 lamp base |

Lighting

Emergency luminaire For fluorescent lamps

GRP

6409/542-9607-1622-7 Art. No. 240895



Lighting Data

| | |
|------------------------|---------------------------------------|
| Luminaire efficacy | 0 lm/W |
| Luminous flux | 0 lm |
| Operating time | 1.5 / 3h emergency lighting operation |
| Emergency light mode | Continuous light Or stand-by light |
| Emergency light output | 30% – 3 h 60% – 1.5 h |

Ambient Conditions

| | |
|---------------------|---|
| Ambient temperature | -30 °C ... +50 °C Note: Through wiring Max. 3x16 A -30 °C ... +55 °C Note: Through wiring 2 Max. 3x8 A |
|---------------------|---|

Mechanical Data

| | |
|---|---|
| Version | Standard |
| IP degree of protection (IEC 60598) | IP66 / IP67 |
| Class | I (with inner PE connection) |
| Enclosure material | Polyester resin, Glass fibre reinforced |
| Enclosure colour | Light grey (RAL 7035) |
| Sealing material | Silicone |
| Silicone-free content | Contains silicone |
| Translucent cover material | Polycarbonate |
| Installed terminal strip | PE + N + L1 + L2 + L3 + L' |
| Max. solid connection terminals | 6 mm ² |
| Max. finely stranded connection terminals | 4 mm ² |
| Type of connection cable | Solid Finely stranded |
| Size | 4 |
| Width | 183.5 mm |
| Height | 125 mm |
| Length | 1467 mm |
| Impact strength (IEC 62262) | IK10 |
| Weight | 9.63 kg |
| Weight | 21.23 lb |
| Disconnection of the luminaire | Only battery |

Components

| | |
|--------------------------|---------------------------------------|
| Threaded plate | 2x stainless steel |
| Ballast | 6043/792-201 |
| Through wiring | With 6 conductors 2.5 mm ² |
| Battery-Version | NiCd battery, gas-tight |
| Drilled holes | 3 x M20 |
| Cable glands and entries | Can be ordered as accessories |
| Stopping plugs | Can be ordered as accessories |
| Accessories | without |

Lighting

Emergency luminaire For fluorescent lamps

GRP

6409/542-9607-1622-7 Art. No. 240895



Dimensional Drawings (All Dimensions in mm [inches]) – Subject to Alterations

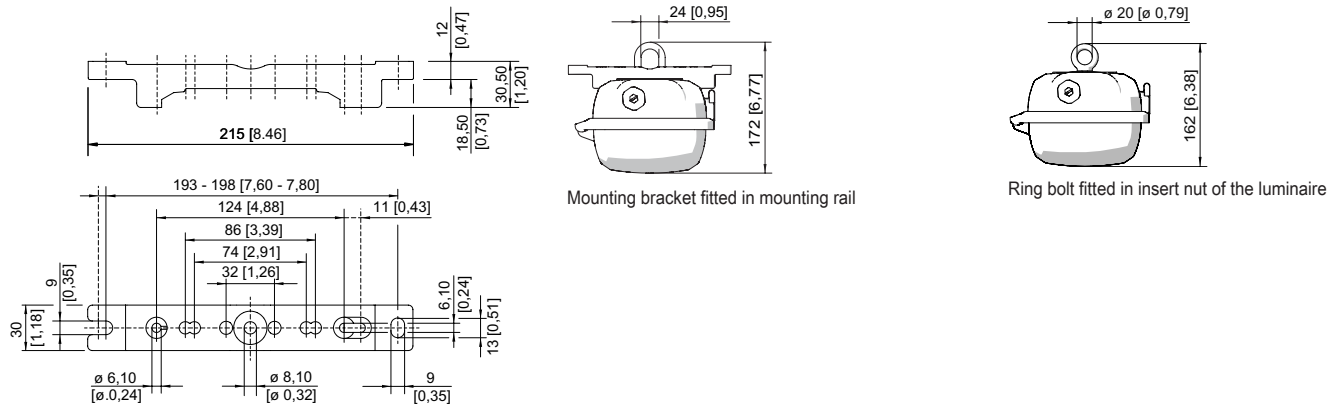

Mounting rail

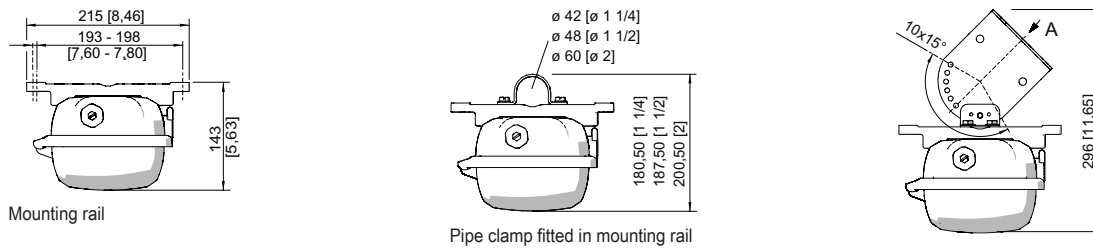

Mounting rail

Pipe clamp fitted in mounting rail

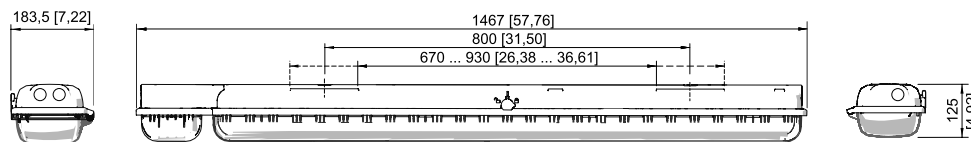
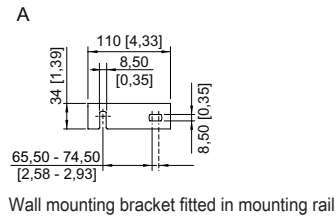

Size 4

Accessories

Box spanner

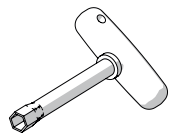

M8 / A/F 13;
For actuating the central lock

Art. No.

222430

Breather

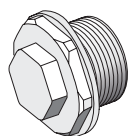

Thread: M25 x 1.5 (1 piece); for installation in light fittings; made from stainless steel; without jam nut

Art. No.

296608

Lighting

Emergency luminaire For fluorescent lamps

GRP

6409/542-9607-1622-7 Art. No. 240895

STAHL

Ceiling and wall mounting bracket

Art. No.

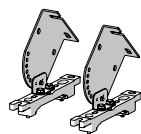

mounted on a mounting rail for a variable mounting distance; Material: stainless steel; Lamp can be swiveled in steps of 15°; 1 pair

222827

Cover

Art. No.

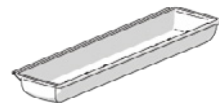

For size 4 luminaires (diffuse), when used on an emergency luminaire with individual power supply, the visibility of the display LED may be restricted

276670

Holder for translucent cover

Art. No.



The fall prevention system for the light fitting cover prevents the light fitting cover from falling accidentally when the light fitting is opened.

226791

Mounting bracket

Art. No.

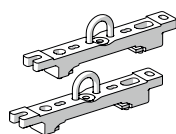

mounting clamp mounted on a mounting rail for a variable mounting distance; 1 pair

222456

Mounting rail

Art. No.

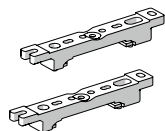

for a variable mounting distance; 1 pair

222826

Pipe clamp

Art. No.

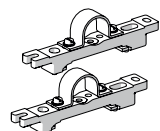

R 1 1/2"; with mounting rail for a variable mounting distance; material: stainless steel; 1 pair

222459

R 1 1/4"; with mounting rail for a variable mounting distance; Material: stainless steel; 1 pair

222458

R 2"; with mounting rail for a variable mounting distance; Material: stainless steel; 1 pair

222460

Ring bolt

Art. No.



M8, direct mounting in insert nuts; 1 pair

115736

Spare Parts

Battery set

Art. No.

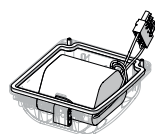

Battery cover with built-in battery. Gas-tight NiCd battery; 7 Ah / 6 V

223532

Lighting

Emergency luminaire For fluorescent lamps

GRP

6409/542-9607-1622-7 Art. No. 240895



Contact element

Art. No.



8080/1-3-L 2 NC contact element

132527

Cover

Art. No.

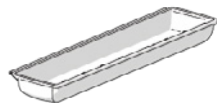

for luminaire size 4

222428

Fluorescent lamp

Art. No.

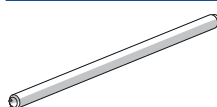

36 W, 3350 lm

108951

We reserve the right to make alterations to the technical data, dimensions, weights, designs and products available without notice. The illustrations cannot be considered binding.