

Installation equipment

Wall-mounting socket 16 A compact Extra-low voltage



8573/13-311 Art. No. 243154



- Compact dimensions
- Wide temperature range for use
- High mechanical impact and shock resistance
- Perfect protection against the ingress of liquids and dust
- 3D data available to download from the website

MY R. STAHL 8573B



The sockets of the new R. STAHL Series 8573/13 are for 2- or 3-pole applications up to 16 A. The compact sockets for extra-low voltage up to 50 V are made from robust and chemical-resistant plastics. Self-cleaning lamellar contacts provide optimum contact. The integrated rotary switch mechanism and integrated locking device reliably prevent disconnection under loads. The new compact socket from Series 8573/13 replaces Series 8575 sockets, is 100% compatible with this series and can be used with Series 8575 plugs.

Technical Data

Explosion Protection

Scope of validity	European Union (ATEX) IECEX China (CQST)
Application range (zones)	1 2 21 22
IECEX gas certificate	IECEX PTB 16.0029
IECEX gas explosion protection	Ex db eb IIC T6 Gb
IECEX dust certificate	IECEX PTB 16.0029
IECEX dust explosion protection	Ex tb IIIC T70 °C Db
ATEX gas certificate	PTB 16 ATEX 1017
ATEX gas explosion protection	⊕ II 2 G Ex db eb IIC T6 Gb
ATEX dust certificate	PTB 16 ATEX 1017
ATEX dust explosion protection	⊕ II 2 D Ex tb IIIC T70 °C Db
Certificates	ATEX (PTB), China (CQST), IECEX (PTB)
Declaration of Conformity	ATEX (EUK), China (CCC)
Explosion protection note	Product label may vary. Series devices have certification according to ATEX and IECEX.

Electrical Data

Rated operational voltage AC	20 to 25 & 40 to 50 V AC
Rated operational current	max. 12 A
Electrical service life	> 5x10 ³ switching cycles
Mechanical service life	> 5x10 ³ switching cycles
Type of voltage	Extra-low voltage
Frequency range	> 400 – 500 Hz

Installation equipment

Wall-mounting socket 16 A compact Extra-low voltage



8573/13-311 Art. No. 243154

Device Specific Data

Back-up fuse with thermal protection	35 A gG
Back-up fuse without thermal protection	16 A gG

Ambient Conditions

Ambient temperature	-50 °C to +60 °C
Ambient temperature	-58 °F to +140 °F
Ambient temperature note	For further information, see the operating instructions.

Mechanical Data

Degree of protection IP (IEC 60529)	IP66
IP degree of protection (IEC 60079)	IP64
Enclosure material	Polyamide, Glass fibre reinforced
Silicone-free	No
Silicone-free note	Optional: Silicone-free variant available on request (ambient temperature -40 °C to +60 °C)
Solid connection cross-section	1 x 0.75 mm ² ... 2 x 4 mm ²
Connection cross-section AWG single stranded	1 x AWG 18 ... 2 x AWG 12
Finely stranded connection cross-section	1 x 0.75 mm ² ... 2 x 4 mm ²
Finely stranded connection cross-section AWG	1 x AWG 18 ... 2 x AWG 12
Width	106 mm
Width in inches	4.17 in
Height	138 mm
Height, inches	5.43 in
Length	180 mm
Length, inches	7.08 in
Impact strength (IEC 60079)	7 J
Colour code	Green
Coding (clock hour position)	11
Series	SolConeX
Detailed number of poles	3 P
Weight	300 g
Weight	0.66 lb

Mounting / Installation

Connection	Screw terminal
------------	----------------

Components

Cable entry note	Entry 1: Lower left Entry 2: Lower right
Sopping plug note	when used in an application range of < -40 °C, the seal is only intended for a one-time installation replace the seal before mounting it again
Entry 1 model	8161/7-M25-1707-LT
Entry 1 type	Polyamide cable gland
Entry 1	M25 x 1.5
Entry 1 terminal area	7 – 17 mm
Entry 1 clamping range, inch	0.28 – 0.67 in
Metal entry possible 1	No

Installation equipment

Wall-mounting socket 16 A compact Extra-low voltage



8573/13-311 Art. No. 243154

Components

Entry 2 model	8290/3-M25
Entry 2 type	Polyamide stopping plug
Entry 2	M25 x 1.5
Metal entry possible 2	No

Technical Drawings – Subject to Alterations

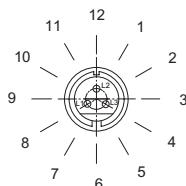

Position of clock hour position
Example: 6 h position

Dimensional Drawings (All Dimensions in mm [inches]) – Subject to Alterations

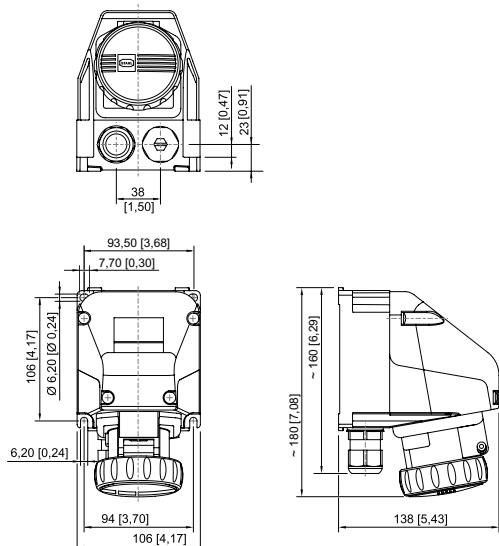

Compact wall-mounting socket, extra-low voltage

Accessories

Dust cover for socket, compact, extra-low voltage, Series 8573/13

Art. No.



Retrofittable dust protection for 2/3-pole sockets

257439

We reserve the right to make alterations to the technical data, dimensions, weights, designs and products available without notice. The illustrations cannot be considered binding.