

Control and signalling devices

Control device system Series ConSig 8040



ConSig

8040/1380X-10L07SA06-35C03SA45-35C03SA45 Art. No. 244091



- Flexible: Modular design and three sizes make customer-specific versions possible
- Lightweight enclosure made of glass fibre reinforced polyester resin (GRP), suitable for the marine industry and offshore applications

MY R. STAHL 8040B



With the R. STAHL Series 8040 control device system, you can get a clear overview of the control devices. The three combinable sizes and the modular design offer flexibility. You can choose from one standard version and customised variants.

Technical Data

Explosion Protection

Area of application	IECEX European Union (ATEX)
Application range (zones)	1, 2, 21, 22
IECEX gas certificate	IECEX PTB 06.0025
IECEX gas explosion protection	Ex db eb IIC T6 Gb
IECEX dust certificate	PTB 01 ATEX 1105
IECEX dust explosion protection	Ex tb IIIC T80 °C Db
ATEX gas certificate	PTB 01 ATEX 1105
ATEX gas explosion protection	⊕ II 2 G Ex db eb IIC T6 Gb
ATEX dust certificate	PTB 01 ATEX 1105
ATEX dust explosion protection	⊕ II 2 D Ex tb IIIC T80 °C Db
Certificates	ATEX (PTB), Canada (UL), China (NEPSI), IECEX (PTB), USA (UL)
Declaration of conformity	ATEX (EUK), China (CCC)
Explosion protection note	Product label may vary. Series devices are labelled with ATEX and IECEX.

Electrical Data

AC rated operational voltage	690 V
Rated operational current	10 A (T6)

Ambient Conditions

Ambient temperature	-60 °C ... 40 °C (T6)
Ambient temperature	-76 °F ... 104 °F (T6)

Mechanical Data

Degree of protection IP (IEC 60529)	IP66
Enclosure material	Polyester resin, Glass fibre reinforced
Enclosure colour	Dark grey
Silicone-free	No
Connection cross-section max.	2.5 mm ²
Solid connection cross section	0.32 – 2.5 mm ²

8040/1380X-10L07SA06-35C03SA45-35C03SA45 Art. No. 244091

Mechanical Data

Connection cross-section AWG single stranded	22 AWG ... 14 AWG
Finely stranded connection cross section	0.32 – 2.5 mm ²
Finely stranded connection cross-section AWG	22 AWG ... 14 AWG
Cover fixing type	With captive screws, M4 stainless steel screws
Width	80 mm
Width, inches	3.15 in
Height	185 mm
Height in inches	7.28 in
Depth	72 mm
Depth in inches	2.76 in
Seal	Silicone, foamed
Weight	717 g

Mounting / Installation

Tightening torque of cover screw 1	1.4 N · m
Tightening torque of cover screw 1 lbf in	12.4 lbf in

Components

Installation position top	EM-STOP mushroom stay-put but., Red – (rotating arrow), With silicone seal
Built-in element top	Contact element NC / NC / NC
Installation position middle	LED illuminated pushbutton, Clear
Built-in element middle	Contact element NO / LED / NC
Installation position bottom	LED illuminated pushbutton, Clear
Built-in element bottom	Contact element NC/LED/NO
Flange and plates	Without flange, without plates
Cable glands and entries	1 x M25 Ø 7 ... 17 mm
Entry type	Standard 8161, moulded material
Entry 1	1 x 8161/7-M25-1707-LT
Entry 1 type	Polyamide cable gland, black
Entry 1	M25 x 1.5
Entry 1 clamping range	7 – 17 mm
Entry 1 clamping range, inch	0.28 – 0.67 in
Metal entry possible 1	No

Dimensional Drawings (All Dimensions in mm [inches]) – Subject to Alterations

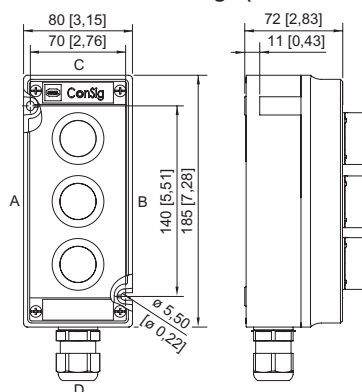

ConSig 8040/13



8040/1380X-10L07SA06-35C03SA45-35C03SA45 Art. No. 244091

Accessories

Illuminated pushbutton (spring return)

		Art. No.
BG735		
	Ø 39 mm Black Front panel mounting All colours Silicone-free: No	244655



Locking devices

		Art. No.
	8602C3-752 for actuated mushroom stay-put button BG010, BG012	244869
	8602C3-756 for actuated mushroom stay-put button BG010, BG012	244873

Mushroom stay-put button EM-STOP



		Art. No.
BG010		
	Ø 39 mm Yellow/red Designation plate: With yellow backing plate Front panel mounting Silicone-free: No	223698

Protective collar

		Art. No.
	8602C3-751 plastic/yellow for mushroom stay-put button with key lock/mushroom stay-put button dia. 39 BG006, BG009, BG010, BG012	257708
	8602C3-751 plastic/red for mushroom stay-put button with key lock/mushroom stay-put button dia. 39 BG006, BG009, BG010, BG012	257707

Spare Parts

Label holder



		Art. No.
	Size 1, without insert disc, 1-line label for actuators Ø 39	223566
	Size 2, without insert disc, 1- or 2-line label for actuators Ø 39	223567

Control and signalling devices

Control device system Series ConSig 8040

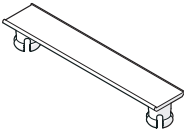

8040/1380X-10L07SA06-35C03SA45-35C03SA45 Art. No. 244091

Label holder		Art. No.
	Size 3, without insert disc, 1-, 2- or 3-line label for actuators Ø 39	223568
Special key		Art. No.
	for tightening plastic locking nut	169101
Tag label		Art. No.
	plain for attaching to enclosure 8040; moulded material; with paper insert strip	130673

We reserve the right to make alterations to the technical data, dimensions, weights, designs and products available without notice. The illustrations cannot be considered binding.