

8602C3-008-S-M03-03-MS01 Art. No. 244633



- Pushbutton, mushroom pushbutton, mushroom stay-put button with key lock, mushroom stay-put button, twin pushbutton and illuminated pushbutton, rotary actuator, key-operated switch, potentiometer bezel and indicator lamp bezel
- One axial actuator can actuate up to four Series 8082 contact elements
- Key-operated switches and rotary switches codable at any time as "latching/spring return" or "key not removable"

MY R. STAHL 8602A



Thanks to their special technical features, the actuators from the 8602/3 series can withstand the most extreme conditions. In addition to the application option for use in ambient temperatures from -60 °C to +70 °C, the IP degree of protection, IP66, is maintained in accordance with EN 60529. It is also possible to actuate up to four contact elements from the 8082 series with a single axial actuator from the 8602/3 series.

The coding option of the key switches and rotary switches is innovative and one-of-a-kind. Integrated coding allows you to adjust the "latching/spring return" and/or "key not removable" functions at any time without additional accessories. A versatile set of accessories consisting of label holders and locking devices is available.

### Technical Data

#### Explosion Protection

|                                 |  |
|---------------------------------|--|
| Application range (zones)       | 1, 2, 21, 22   |
| IECEX gas certificate           | IECEX PTB 13.0047U   |
| IECEX gas certificate           | IECEX PTB 13.0047U   |
| IECEX gas explosion protection  | Ex eb IIC Gb   |
| IECEX dust certificate          | IECEX PTB 13.0047 U  |
| IECEX dust explosion protection | Ex tb IIIC Db  |
| ATEX gas certificate            | PTB 13 ATEX 1019 U   |
| ATEX gas certificate            | PTB 13 ATEX 1019 U   |
| ATEX gas explosion protection   | Ex II 2 G Ex eb IIC Gb   |
| ATEX dust certificate           | PTB 13 ATEX 1019 U   |
| ATEX dust explosion protection  | Ex II 2 D Ex tb IIIC Db  |
| UL gas certificate              | E182378 V4 S2  |
| Inmetro gas certificate         | UL-BR 14.0380U   |
| Inmetro dust certificate        | UL-BR 14.0380U   |
| Certificates                    | ATEX (PTB), Brazil (ULB), Canada / USA (UL), Canada (UL), IECEX (PTB), India (PESO), Korea (KGS) |

#### Ambient Conditions

|                         |                    |
|-------------------------|--------------------|
| Ambient temperature     | -60 °C ... 70 °C   |
| Ambient temperature     | -76 °F ... +158 °F |
| Storage temperature     | -60 °C ... 70 °C   |
| Storage temperature     | -76 °F ... +158 °F |
| Use at the height of    | < 2000 m           |
| Max. operating altitude | 2000 m             |

8602C3-008-S-M03-03-MS01 Art. No. 244633

### Ambient Conditions

|                         |   |
|-------------------------|---|
| Degree of contamination | 3 |
|-------------------------|---|

### Mechanical Data

|                               |   |
|-------------------------------|---|
| Degree of protection (IP)     | IP66  |
| Note on degree of protection  | According to IEC/EN 60529   |
| Enclosure material            | Polyamide   |
| Silicone-free                 | No  |
| Number of switching positions | 3   |
| Assembly                      | 008   |
| Diameter                      | 39 mm   |
| Service life, min.            | 10 <sup>5</sup> actuations  |
| Impact strength (IEC 60079)   | 7 J   |
| Impact strength (IEC 62262)   | min. IK08   |
| Colour                        | Black   |
| Fastening                     | Thread type   |
| Seal                          | Silicone  |
| Closing                       | MS1   |
| Packaging unit                | 1   |
| Weight                        | 50 g  |
| Weight                        | 0.11 lb   |
| Description note              | Conversion to the "spring return" or "key not removable" function is possible with the installed coding elements.<br>Additional closures on request.<br>Two keys enclosed. Pressure plates for 1–2 and 3–4 contact elements enclosed. |

### Mounting / Installation

|                          |                      |
|--------------------------|----------------------|
| Mounting type            | Front panel mounting |
| Tightening torque        | 3 Nm                 |
| Tightening torque lbf in | 26.55 lbf in         |

### Technical Drawings – Subject to Alterations

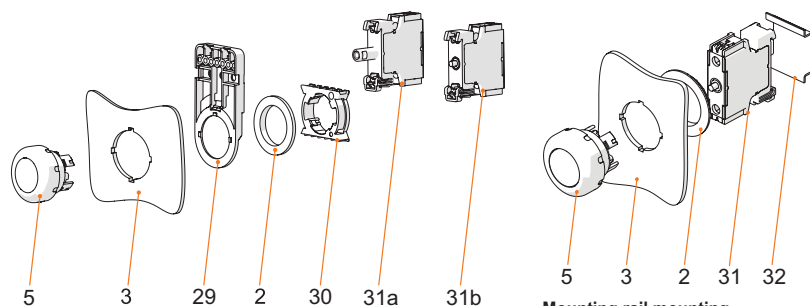

Front installation mounting with Series 8010/6 indicator lamp and Series 8082/3 contact element

Mounting rail mounting

#### Key

#### Key

- 2 = jam nut (order no. 205592)
- 3 = installation wall (wall thickness max. 5 mm [0.197 inch])
- 5 = actuator with seal
- 29 = support for cable duct (optional) (order no. 248673)
- 30 = adaptor (order no. 227038)
- 31a = built-in element: LED element 8010/6
- 31b = built-in element: Contact element 8082/3

- 2 = jam nut (order no. 205592)
- 3 = installation wall (wall thickness max. 5 mm [0.197 inch])
- 5 = actuator with seal
- 31 = built-in element
- 32 = TS35 mounting rail

8602C3-008-S-M03-03-MS01 Art. No. 244633

### Dimensional Drawings (All Dimensions in mm [inches]) – Subject to Alterations

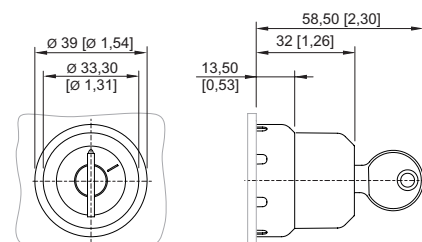
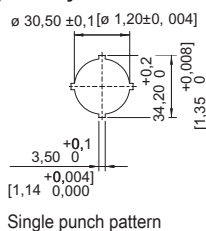
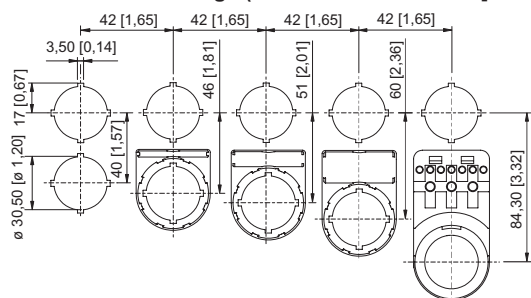

8602/3-008 MS key-operated switch Actuator with axial actuation

Cut-out with/without additional designation plate

## Accessories

### Spare key



Closing MS1

Art. No.

107109

## Spare Parts

### Insert discs for label holder

|  |  | Art. No. |
|--|--|----------|
|  | One-line<br>Plain<br>Material: PVC<br>Colour: White<br>Self-adhesive   | 238271   |
|  | Two-line<br>Plain<br>Material: PVC<br>Colour: White<br>Self-adhesive   | 238272   |
|  | Three-line<br>Plain<br>Material: PVC<br>Colour: White<br>Self-adhesive | 238273   |

### Closing part



8602C3-733-B  
for closing unused holes in cover, dia. 30.5 mm, NBR

8602C3-733-S  
for closing unused holes in cover, dia. 30.5 mm, silicone

Art. No.

244306

244307

### Label holder



Size 1, without insert disc, 1-line label  
for actuators Ø 39

Art. No.







223566

# Installation equipment

## Key-operated switch actuator



8602C3-008-S-M03-03-MS01 Art. No. 244633

|  |  |                 |
|--|--|-----------------|
|    | Size 2, without insert disc, 1- or 2-line label for actuators Ø 39                           | 223567          |
| <b>Special key</b>   |  | <b>Art. No.</b> |
|    | for tightening plastic locking nut   | 169101          |
| <b>Pressure plates</b>   |  | <b>Art. No.</b> |
|    | For key-operated switch and axial rotary actuator 1 to 2 contact elements                    | 253627          |
|    | For key-operated switch and axial rotary actuator 3 to 4 contact elements                    | 221707          |
| <b>Holder for front installation</b>   |  | <b>Art. No.</b> |
|  | 8602/3 holder for cable duct   | 248673          |
| <b>Adaptor for front installation</b>  |  | <b>Art. No.</b> |
|  | 8602/3 Front installation for indicator lamp series 8010/6 and contact element series 8082/3 | 227038          |
| <b>8082/3 Contact element</b>  |  | <b>Art. No.</b> |
|  | For NC front installation  | 240898          |
|  | for NO contact front installation  | 240899          |

We reserve the right to make alterations to the technical data, dimensions, weights, designs and products available without notice. The illustrations cannot be considered binding.