

## Installation equipment

Mushroom stay-put button 55 mm

EMERGENCY STOP

8602C3-015-S Art. No. 244637



- Pushbutton, mushroom pushbutton, mushroom stay-put button with key lock, mushroom stay-put button, twin pushbutton and illuminated pushbutton, rotary actuator, key-operated switch, potentiometer bezel and indicator lamp bezel
- One axial actuator can actuate up to four Series 8082 contact elements
- Key-operated switches and rotary switches codable at any time as "latching/spring return" or "key not removable"

MY R. STAHL 8602A



Thanks to their special technical features, the actuators from the 8602/3 series can withstand the most extreme conditions. In addition to the application option for use in ambient temperatures from -60 °C to +70 °C, the IP degree of protection, IP66, is maintained in accordance with EN 60529. It is also possible to actuate up to four contact elements from the 8082 series with a single axial actuator from the 8602/3 series.

The coding option of the key switches and rotary switches is innovative and one-of-a-kind. Integrated coding allows you to adjust the "latching/spring return" and/or "key not removable" functions at any time without additional accessories. A versatile set of accessories consisting of label holders and locking devices is available.

## Technical Data

### Explosion Protection

Application range (zones)	1, 2, 21, 22
IECEX gas certificate	IECEX PTB 13.0047U
IECEX gas explosion protection	Ex eb IIC Gb
IECEX dust certificate	IECEX PTB 13.0047 U
IECEX dust explosion protection	Ex tb IIIC Db
ATEX gas explosion protection	Ex II 2 G Ex eb IIC Gb
ATEX dust explosion protection	Ex II 2 D Ex tb IIIC Db
UL gas certificate	E182378 V4 S2
Certificate ULus	E182378 V4 S2
Marking ULus	Class I, Zone 1, AEx eb IIC Gb Zone 21, AEx tb IIIC Db
Certificate cUL	E182378V4S2
Marking cUL	Class I, Zone 1, Ex eb IIC Gb Zone 21, Ex tb IIIC Db
Inmetro gas certificate	UL-BR 14.0380U
Inmetro dust certificate	UL-BR 14.0380U
Certificates	ATEX (PTB), Brazil (ULB), Canada / USA (UL), Canada (UL), IECEX (PTB), Korea (KGS), USA (UL)

### Ambient Conditions

Ambient temperature	-60 °C ... 70 °C
Ambient temperature	-76 °F ... +158 °F
Storage temperature	-60 °C ... 70 °C
Storage temperature	-76 °F ... +158 °F

# Installation equipment

## Mushroom stay-put button 55 mm

### EMERGENCY STOP

8602C3-015-S Art. No. 244637



#### Ambient Conditions

Use at the height of	< 2000 m
Max. operating altitude	2000 m
Degree of pollution	3

#### Mechanical Data

Version	55 mm
Degree of protection (IP)	IP66
Note on degree of protection	According to IEC/EN 60529
Enclosure material	Polyamide
Silicone-free	No
Assembly	015
Diameter	55 mm
Service life, min.	10 <sup>5</sup> actuations
Impact strength (IEC 60079)	7 J
Impact strength (IEC 62262)	min. IK08
Colour	Yellow/red
Mounting	Thread type
Designation plate	With yellow backing plate
Seal	Silicone
Packaging unit	1
Weight	55 g
Weight	0.12 lb

#### Mounting / Installation

Mounting type	Front panel mounting
Tightening torque	3 N · m
Tightening torque lbf in	26.55 lbf in

#### Technical Drawings – Subject to Alterations

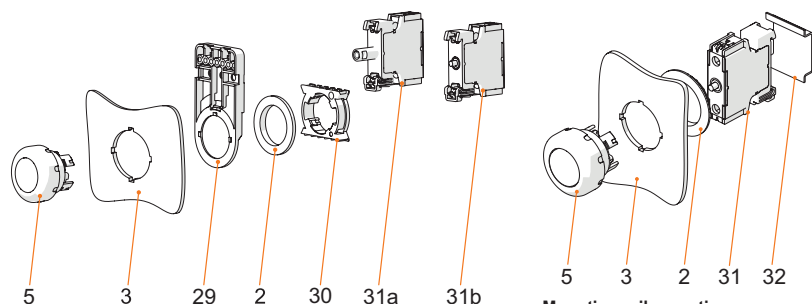

Front installation mounting with Series 8010/6 indicator lamp and Series 8082/3 contact element

#### Key

- 2 = jam nut (order no. 205592)
- 3 = installation wall (wall thickness max. 5 mm [0.197 inch])
- 5 = actuator with seal
- 29 = support for cable duct (optional) (order no. 248673)
- 30 = adaptor (order no. 227038)
- 31a = built-in element: LED element 8010/6
- 31b = built-in element: Contact element 8082/3

#### Mounting rail mounting

- 2 = jam nut (order no. 205592)
- 3 = installation wall (wall thickness max. 5 mm [0.197 inch])
- 5 = actuator with seal
- 31 = built-in element
- 32 = TS35 mounting rail

# Installation equipment

## Mushroom stay-put button 55 mm

### EMERGENCY STOP

8602C3-015-S Art. No. 244637



#### Dimensional Drawings (All Dimensions in mm [inches]) – Subject to Alterations

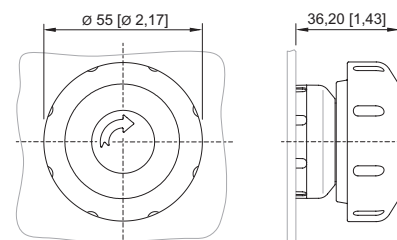
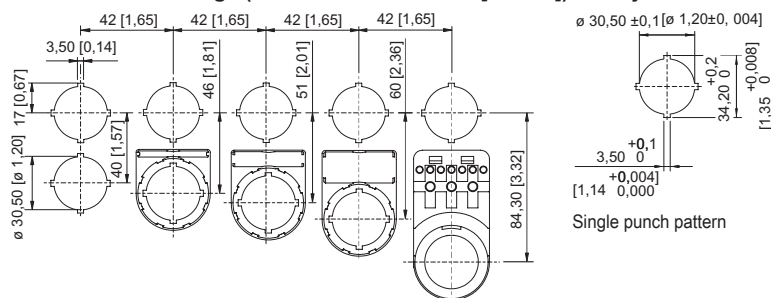

8602/3-015 red/yellow mushroom stay-put button  
Actuator with axial actuation

Cut-out with/without additional designation plate

## Accessories

### Closing part



8602C3-733-S  
for closing unused holes in cover, dia. 30.5 mm, silicone

### Art. No.

244307

## Spare Parts

### Contact element



for NC front installation, 10 pieces

### Art. No.

315697

for NO front installation, 10 pieces

315698

for NC front installation, 5 pieces

315699

for NO front installation, 5 pieces

for NC front installation

240898

for NO contact front installation

240899

### Label, yellow, general



for special, Ø 55 actuator (EM-STOP), e.g. series 8040

### Art. No.

223573

### Designation plate for pushbutton and selector switch



Black  
Text: O

### Art. No.

227741



Black  
Text: I

227747



Black  
Text: II

227754

## Installation equipment

Mushroom stay-put button 55 mm

EMERGENCY STOP

8602C3-015-S Art. No. 244637



### Designation plate for pushbutton and selector switch

Art. No.

	Black Symbol: Straight arrow, 45°	227778
	Black Text: EIN	227808
	Black Text: AUS	227811
	Blue Text: RESET	227926
	Green Text: I	227750
	Green Text: II	227753
	Green Text: START	227801
	Red Text: STOP	227804
	Red Text: AUS	227810
	Red Text: OFF	227814
	Red Text: O	227740

# Installation equipment

Mushroom stay-put button 55 mm



EMERGENCY STOP

8602C3-015-S Art. No. 244637

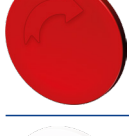

## Designation plate for pushbutton and selector switch

Art. No.

	White Text: I	227751
	Black Blank disc without text	215425
	Blue Blank disc without text	215427
	Green Blank disc without text	215424
	Red Blank disc without text	215423
	Red Symbol: Right arrow	272628
	White Blank disc without text	215426
	Yellow Blank disc without text	215428



## Special key

Art. No.

	for tightening plastic locking nut	169101
--	------------------------------------	--------

## Pressure plates

Art. No.

	Dia. 37 mm Three contact elements	215436
	Dia. 48.5 mm Four contact elements	215437

## Installation equipment

Mushroom stay-put button 55 mm

EMERGENCY STOP

8602C3-015-S Art. No. 244637



### Holder for front installation

Art. No.



8602/3 holder for cable duct

248673

### Adaptor for front installation

Art. No.



8602/3 Front installation for indicator lamp series 8010/6 and contact element series 8082/3

227038

We reserve the right to make alterations to the technical data, dimensions, weights, designs and products available without notice. The illustrations cannot be considered binding.