

8602C3-703-B Art. No. 244642



- Pushbutton, mushroom pushbutton, mushroom stay-put button with key lock, mushroom stay-put button, twin pushbutton and illuminated pushbutton, rotary actuator, key-operated switch, potentiometer bezel and indicator lamp bezel
- One axial actuator can actuate up to four Series 8082 contact elements
- Key-operated switches and rotary switches codable at any time as "latching/spring return" or "key not removable"

MY R. STAHL 8602A



Thanks to their special technical features, the actuators from the 8602/3 series can withstand the most extreme conditions. In addition to the application option for use in ambient temperatures from -60 °C to +70 °C, the IP degree of protection, IP66, is maintained in accordance with EN 60529. It is also possible to actuate up to four contact elements from the 8082 series with a single axial actuator from the 8602/3 series.

The coding option of the key switches and rotary switches is innovative and one-of-a-kind. Integrated coding allows you to adjust the "latching/spring return" and/or "key not removable" functions at any time without additional accessories. A versatile set of accessories consisting of label holders and locking devices is available.

Technical Data

Explosion Protection	
Application range (zones)	1, 2, 21, 22
IECEX gas certificate	IECEX PTB 13.0047U
IECEX gas certificate	IECEX PTB 13.0047U
IECEX gas explosion protection	Ex eb IIC Gb
IECEX dust certificate	IECEX PTB 13.0047 U
IECEX dust explosion protection	Ex tb IIIC Db
ATEX gas certificate	PTB 13 ATEX 1019 U
ATEX gas certificate	PTB 13 ATEX 1019 U
ATEX gas explosion protection	Ex II 2 G Ex eb IIC Gb
ATEX dust certificate	PTB 13 ATEX 1019 U
ATEX dust explosion protection	Ex II 2 D Ex tb IIIC Db
UL gas certificate	E182378 V4 S2
Inmetro gas certificate	UL-BR 14.0380U
Inmetro dust certificate	UL-BR 14.0380U
Certificates	ATEX (PTB), Brazil (ULB), Canada / USA (UL), Canada (UL), IECEX (PTB), India (PESO), Korea (KGS)

Ambient Conditions	
Ambient temperature	-20 °C ... 60 °C
Ambient temperature	-4 °F ... +140 °F
Storage temperature	-25 °C ... 60 °C
Storage temperature	-13 °F ... +140 °F
Use at the height of	< 2000 m
Max. operating altitude	2000 m

Installation equipment

Mushroom pushbutton 55 mm



8602C3-703-B Art. No. 244642

Ambient Conditions

Degree of contamination	3
-------------------------	---

Mechanical Data

Version	55 mm
Degree of protection (IP)	IP66
Note on degree of protection	According to IEC/EN 60529
Enclosure material	Polyamide
Silicone-free	Yes
Assembly	703
Diameter	55 mm
Service life, min.	10 ⁵ actuations
Impact strength (IEC 60079)	7 J
Impact strength (IEC 62262)	min. IK08
Colour	Black
Fastening	Thread type
Designation plate	Black, blank disc without text
Seal	Standard
Packaging unit	1
Weight	55 g
Weight	0.12 lb

Mounting / Installation

Mounting type	Front panel mounting
Tightening torque	3 Nm
Tightening torque lbf in	26.55 lbf in

Technical Drawings – Subject to Alterations

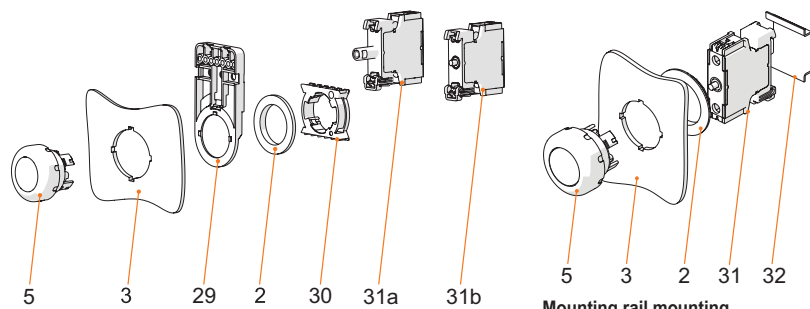

Front installation mounting with Series 8010/6 indicator lamp and Series 8082/3 contact element

Mounting rail mounting

Key

- 2 = jam nut (order no. 205592)
- 3 = installation wall (wall thickness max. 5 mm [0.197 inch])
- 5 = actuator with seal
- 29 = support for cable duct (optional) (order no. 248673)
- 30 = adaptor (order no. 227038)
- 31a = built-in element: LED element 8010/6
- 31b = built-in element: Contact element 8082/3

Key

- 2 = jam nut (order no. 205592)
- 3 = installation wall (wall thickness max. 5 mm [0.197 inch])
- 5 = actuator with seal
- 31 = built-in element
- 32 = TS35 mounting rail

8602C3-703-B Art. No. 244642

Dimensional Drawings (All Dimensions in mm [inches]) – Subject to Alterations

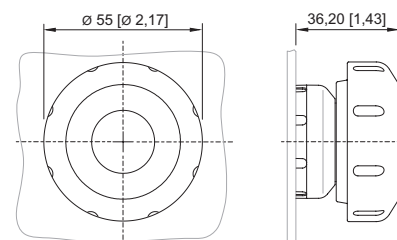
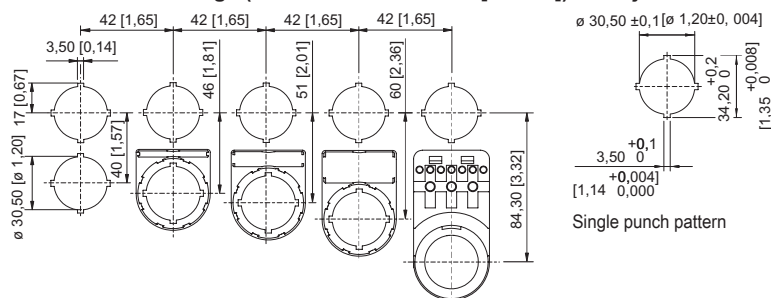

8602/3-014 red/black mushroom pushbutton
8602/3-703 black/black mushroom pushbutton
Actuator with axial actuation

Cut-out with/without additional designation plate

Spare Parts

Designation plate for pushbutton and selector switch

Art. No.

	Black Text: O	227741
	Black Text: I	227747
	Black Text: II	227754
	Black Symbol: Straight arrow, 45°	227778
	Black Text: ON	227808
	Black Text: OFF	227811
	Blue Text: RESET	227926
	Green Text: I	227750

Installation equipment

Mushroom pushbutton 55 mm



8602C3-703-B Art. No. 244642

	Green Text: II	227753
--	-------------------	--------

Designation plates for pushbutton and selector switch

Art. No.

	Green Text: START	227801
--	----------------------	--------

Designation plate for pushbutton and selector switch

Art. No.

	Red Text: STOP	227804
--	-------------------	--------

	Red Text: OFF	227810
--	------------------	--------

	Red Text: OFF	227814
--	------------------	--------

	Red Text: O	227740
--	----------------	--------

	White Text: I	227751
--	------------------	--------

	Black Blank disc without text	215425
--	----------------------------------	--------

	Blue Blank disc without text	215427
--	---------------------------------	--------

	Green Blank disc without text	215424
--	----------------------------------	--------



	Red Blank disc without text	215423
--	--------------------------------	--------

Installation equipment

Mushroom pushbutton 55 mm



8602C3-703-B Art. No. 244642

	Red Symbol: Right arrow	272628
	White Blank disc without text	215426
	Yellow Blank disc without text	215428

Designation plates set for ASSY001, ASSY023

Art. No.

	The button label set contains eight labels 5x blank disc without text in red, green, white, blue and yellow 1x red label, text: STOP 1x green label, text: START 1x blue label, text: RESET	321791
--	---	--------



Special key

Art. No.

	for tightening plastic locking nut	169101
--	------------------------------------	--------

Pressure plates

Art. No.

	Dia. 37 mm Three contact elements	215436
	Dia. 48.5 mm Four contact elements	215437

Holder for front installation

Art. No.

	8602/3 holder for cable duct	248673
--	------------------------------	--------

Adaptor for front installation

Art. No.

	8602/3 Front installation for indicator lamp series 8010/6 and contact element series 8082/3	227038
--	--	--------

Installation equipment

Mushroom pushbutton 55 mm



8602C3-703-B Art. No. 244642

8082/3 Contact element

Art. No.



For NC front installation

240898

for NO contact front installation

240899

We reserve the right to make alterations to the technical data, dimensions, weights, designs and products available without notice. The illustrations cannot be considered binding.