

8602C3-726-B-M01-02-E08 Art. No. 244646



- Pushbutton, mushroom pushbutton, mushroom stay-put button with key lock, mushroom stay-put button, twin pushbutton and illuminated pushbutton, rotary actuator, key-operated switch, potentiometer bezel and indicator lamp bezel
- One axial actuator can actuate up to four Series 8082 contact elements
- Key-operated switches and rotary switches codable at any time as "latching/spring return" or "key not removable"

MY R. STAHL 8602A



Thanks to their special technical features, the actuators from the 8602/3 series can withstand the most extreme conditions. In addition to the application option for use in ambient temperatures from -60 °C to +70 °C, the IP degree of protection, IP66, is maintained in accordance with EN 60529. It is also possible to actuate up to four contact elements from the 8082 series with a single axial actuator from the 8602/3 series.

The coding option of the key switches and rotary switches is innovative and one-of-a-kind. Integrated coding allows you to adjust the "latching/spring return" and/or "key not removable" functions at any time without additional accessories. A versatile set of accessories consisting of label holders and locking devices is available.

Technical Data

Explosion Protection

Application range (zones)	1, 2, 21, 22
IECEX gas certificate	IECEX PTB 13.0047U
IECEX gas explosion protection	Ex eb IIC Gb
IECEX dust certificate	IECEX PTB 13.0047 U
IECEX dust explosion protection	Ex tb IIIC Db
ATEX gas explosion protection	Ex II 2 G Ex eb IIC Gb
ATEX dust explosion protection	Ex II 2 D Ex tb IIIC Db
UL gas certificate	E182378 V4 S2
Certificate ULus	E182378 V4 S2
Marking ULus	Class I, Zone 1, AEx eb IIC Gb Zone 21, AEx tb IIIC Db
Certificate cUL	E182378V4S2
Marking cUL	Class I, Zone 1, Ex eb IIC Gb Zone 21, Ex tb IIIC Db
Inmetro gas certificate	UL-BR 14.0380U
Inmetro dust certificate	UL-BR 14.0380U
Certificates	ATEX (PTB), Brazil (ULB), Canada / USA (UL), Canada (UL), IECEX (PTB), Korea (KGS), USA (UL)

Ambient Conditions

Ambient temperature	-20 °C ... 60 °C
Ambient temperature	-4 °F ... +140 °F
Storage temperature	-25 °C ... 60 °C
Storage temperature	-13 °F ... +140 °F

Installation equipment

Rotary actuator, small not lockable



8602C3-726-B-M01-02-E08 Art. No. 244646

Ambient Conditions

Use at the height of	< 2000 m
Max. operating altitude	2000 m
Degree of pollution	3

Mechanical Data

Version	not lockable
Degree of protection (IP)	IP66
Note on degree of protection	According to IEC/EN 60529
Enclosure material	Polyamide
Silicone-free	Yes
Number of switching positions	2
Assembly	726
Diameter	39 mm
Service life, min.	10 ⁵ actuations
Impact strength (IEC 60079)	7 J
Impact strength (IEC 62262)	min. IK08
Colour	Black
Mounting	Thread type
Designation plate	0/OFF - I/ON
Seal	Standard
Lockable in	Not padlockable
Packaging unit	1
Decription note	Conversion to the "spring return" function is possible with the installed coding elements. Standard label enclosed separately. Different labels must be ordered in addition. Pressure plates for 1–2 and 3–4 contact elements enclosed.
Weight	40 g
Weight	0.09 lb

Mounting / Installation

Mounting type	Front panel mounting
Tightening torque	3 N · m
Tightening torque lbf in	26.55 lbf in

Installation equipment

Rotary actuator, small not lockable



8602C3-726-B-M01-02-E08 Art. No. 244646

Technical Drawings – Subject to Alterations

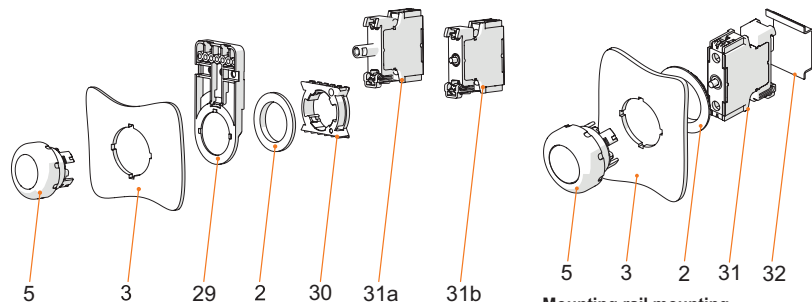

Front installation mounting with Series 8010/6 indicator lamp and Series 8082/3 contact element

- Key**
 2 = jam nut (order no. 205592)
 3 = installation wall (wall thickness max. 5 mm [0.197 inch])
 5 = actuator with seal
 29 = support for cable duct (optional) (order no. 248673)
 30 = adaptor (order no. 227038)
 31a = built-in element: LED element 8010/6
 31b = built-in element: Contact element 8082/3

Mounting rail mounting

- Key**
 2 = jam nut (order no. 205592)
 3 = installation wall (wall thickness max. 5 mm [0.197 inch])
 5 = actuator with seal
 31 = built-in element
 32 = TS35 mounting rail

Dimensional Drawings (All Dimensions in mm [inches]) – Subject to Alterations

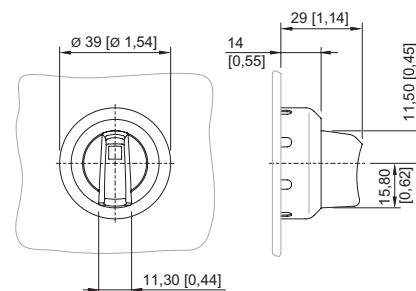
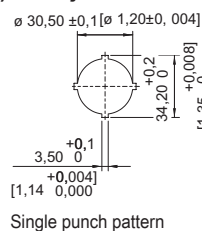
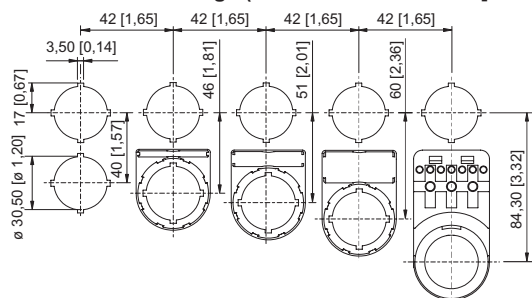

Cut-out with/without additional designation plate

8602/3-726 axial rotary actuator, not lockable
 Actuator with axial actuation

Accessories

Closing part



8602C3-733-B
 for closing unused holes in cover, dia. 30.5 mm, NBR

Art. No.

244306

Spare Parts

Contact element



for NC front installation
 for NO contact front installation

Art. No.

240898

240899

Insert discs for label holder



One-line
 Plain
 Material: PVC
 Colour: White
 Self-adhesive

Art. No.









238271

Installation equipment

Rotary actuator, small not lockable

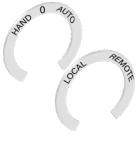

8602C3-726-B-M01-02-E08 Art. No. 244646





Insert discs for label holder		Art. No.
	Two-line Plain Material: PVC Colour: White Self-adhesive	238272
	Three-line Plain Material: PVC Colour: White Self-adhesive	238273
Labels for small BG 732, BG 734 rotary actuator and BG 726, BG 727 axial rotary actuator		Art. No.
	Dia. 30.8 Plain	227495
Labels for axial BG 726, BG 727 rotary actuator		Art. No.
	Dia. 30.8 0/OFF I/ON	240472
	Dia. 30.8 0 I	240475
Label set for BG732		Art. No.
	The label set contains three dia. 30.8 mm labels 1x label with text HAND-0-AUTO 1x label with text LOCAL-REMOTE 1x label blank	321792
Label holder		Art. No.
	Size 1, without insert disc, 1-line label for actuators Ø 39	223566
	Size 2, without insert disc, 1- or 2-line label for actuators Ø 39	223567
	Size 3, without insert disc, 1-, 2- or 3-line label for actuators Ø 39	223568

Installation equipment

Rotary actuator, small not lockable



8602C3-726-B-M01-02-E08 Art. No. 244646

Special key		Art. No.
	for tightening plastic locking nut	169101
Pressure plates		Art. No.
	For key-operated switch and axial rotary actuator 1 to 2 contact elements	253627
	For key-operated switch and axial rotary actuator 3 to 4 contact elements	221707
Holder for front installation		Art. No.
	8602/3 holder for cable duct	248673
Adaptor for front installation		Art. No.
	8602/3 Front installation for indicator lamp series 8010/6 and contact element series 8082/3	227038

We reserve the right to make alterations to the technical data, dimensions, weights, designs and products available without notice. The illustrations cannot be considered binding.