

8602C3-735-S-C06 Art. No. 244655



- Pushbutton, mushroom pushbutton, mushroom stay-put button with key lock, mushroom stay-put button, twin pushbutton and illuminated pushbutton, rotary actuator, key-operated switch, potentiometer bezel and indicator lamp bezel
- One axial actuator can actuate up to four Series 8082 contact elements
- Key-operated switches and rotary switches codable at any time as "latching/spring return" or "key not removable"

MY R. STAHL 8602A



Thanks to their special technical features, the actuators from the 8602/3 series can withstand the most extreme conditions. In addition to the application option for use in ambient temperatures from -60 °C to +70 °C, the IP degree of protection, IP66, is maintained in accordance with EN 60529. It is also possible to actuate up to four contact elements from the 8082 series with a single axial actuator from the 8602/3 series.

The coding option of the key switches and rotary switches is innovative and one-of-a-kind. Integrated coding allows you to adjust the "latching/spring return" and/or "key not removable" functions at any time without additional accessories. A versatile set of accessories consisting of label holders and locking devices is available.

### Technical Data

#### Explosion Protection

Application range (zones)	1, 2, 21, 22
IECEX gas certificate	IECEX PTB 13.0047U
IECEX gas explosion protection	Ex eb IIC Gb
IECEX dust certificate	IECEX PTB 13.0047 U
IECEX dust explosion protection	Ex tb IIIC Db
ATEX gas explosion protection	Ex II 2 G Ex eb IIC Gb
ATEX dust explosion protection	Ex II 2 D Ex tb IIIC Db
UL gas certificate	E182378 V4 S2
Certificate ULus	E182378 V4 S2
Marking ULus	Class I, Zone 1, AEx eb IIC Gb Zone 21, AEx tb IIIC Db
Certificate cUL	E182378V4S2
Marking cUL	Class I, Zone 1, Ex eb IIC Gb Zone 21, Ex tb IIIC Db
Inmetro gas certificate	UL-BR 14.0380U
Inmetro dust certificate	UL-BR 14.0380U
Certificates	ATEX (PTB), Brazil (ULB), Canada / USA (UL), Canada (UL), IECEX (PTB), Korea (KGS), USA (UL)

#### Ambient Conditions

Ambient temperature	-60 °C ... 70 °C
Ambient temperature	-76 °F ... +158 °F
Storage temperature	-60 °C ... 70 °C
Storage temperature	-76 °F ... +158 °F

# Installation equipment

## Illuminated pushbutton Spring return



8602C3-735-S-C06 Art. No. 244655

### Ambient Conditions

Use at the height of	< 2000 m
Max. operating altitude	2000 m
Degree of pollution	3

### Mechanical Data

Version	spring-return
Degree of protection (IP)	IP66
Note on degree of protection	According to IEC/EN 60529
Enclosure material	Polyamide
Silicone-free	No
Assembly	735
Diameter	39 mm
Service life, min.	10 <sup>5</sup> actuations
Impact strength (IEC 60079)	4 J
Impact strength (IEC 62262)	min. IK07
Colour	Black
Lens colour	All colours
Mounting	Thread type
Seal	Silicone
Packaging unit	1
Description note	Pressure plate for 3 contact elements enclosed.
Weight	35 g
Weight	0.08 lb

### Mounting / Installation

Mounting type	Front panel mounting
Tightening torque	3 N · m
Tightening torque lbf in	26.55 lbf in

### Technical Drawings – Subject to Alterations

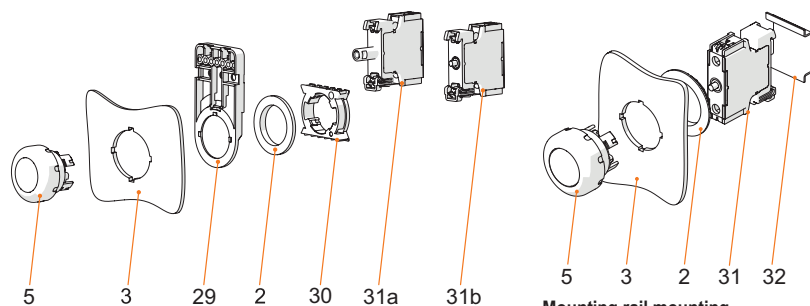

#### Front installation mounting with Series 8010/6 indicator lamp and Series 8082/3 contact element

##### Key

- 2 = jam nut (order no. 205592)
- 3 = installation wall (wall thickness max. 5 mm [0.197 inch])
- 5 = actuator with seal
- 29 = support for cable duct (optional) (order no. 248673)
- 30 = adaptor (order no. 227038)
- 31a = built-in element: LED element 8010/6
- 31b = built-in element: Contact element 8082/3

#### Mounting rail mounting

##### Key

- 2 = jam nut (order no. 205592)
- 3 = installation wall (wall thickness max. 5 mm [0.197 inch])
- 5 = actuator with seal
- 31 = built-in element
- 32 = TS35 mounting rail

# Installation equipment

## Illuminated pushbutton Spring return



8602C3-735-S-C06 Art. No. 244655

### Dimensional Drawings (All Dimensions in mm [inches]) – Subject to Alterations

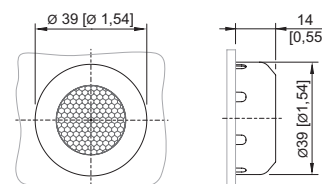
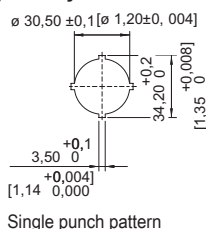
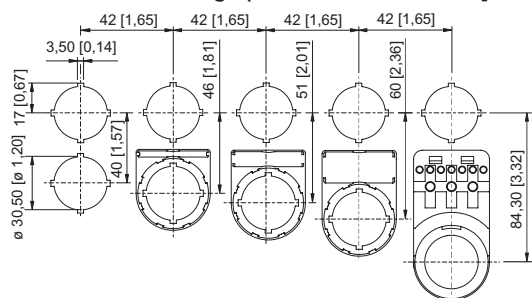

8602/3-735 illuminated pushbutton  
Actuator with axial actuation

Cut-out with/without additional designation plate

## Accessories

### Closing part



8602C3-733-S  
for closing unused holes in cover, dia. 30.5 mm, silicone

### Art. No.

244307

## Spare Parts

### Contact element



for NC front installation, 10 pieces  
for NO front installation, 10 pieces  
for NC front installation, 5 pieces  
for NO front installation, 5 pieces  
for NC front installation  
for NO contact front installation

### Art. No.

315697  
315698  
315699  
240898  
240899

### LED indicator lamp for front installation



for Ex e front installation, 5 pieces  
for Ex e front installation  
for Ex i front installation  
for SA front installation

### Art. No.

315711  
240900  
240901  
274899

### Insert discs for label holder



One-line  
Plain  
Material: PVC  
Colour: White  
Self-adhesive

### Art. No.

238271



Two-line  
Plain  
Material: PVC  
Colour: White  
Self-adhesive

238272



Three-line  
Plain  
Material: PVC  
Colour: White  
Self-adhesive

238273

# Installation equipment

## Illuminated pushbutton Spring return



8602C3-735-S-C06 Art. No. 244655



### Colour filter for BG 735

		Art. No.
	for illuminated pushbutton, all colours packaged	248684

### Designation plates set for BG001, BG023

		Art. No.
	The button label set contains nine labels 6x blank disc without text in red, green, white, blue, yellow and black 1x red label, text: STOP 1x green label, text: START 1x blue label, text: RESET	321791

### Label holder

		Art. No.
	Size 1, without insert disc, 1-line label for actuators Ø 39	223566
	Size 2, without insert disc, 1- or 2-line label for actuators Ø 39	223567
	Size 3, without insert disc, 1-, 2- or 3-line label for actuators Ø 39	223568

### Special key

		Art. No.
	for tightening plastic locking nut	169101

### Pressure plates

		Art. No.
	Dia. 37 mm Three contact elements	215436

### Holder for front installation

		Art. No.
	8602/3 holder for cable duct	248673

### Adaptor for front installation

		Art. No.
	8602/3 Front installation for indicator lamp series 8010/6 and contact element series 8082/3	227038

## Installation equipment

Illuminated pushbutton Spring return



8602C3-735-S-C06 Art. No. 244655

---

We reserve the right to make alterations to the technical data, dimensions, weights, designs and products available without notice. The illustrations cannot be considered binding.