

Signalling Devices



Visual signalling device LED continuous beacon

In flameproof enclosure

FX15/B-D-060-R-EN-RN-A-ST-00-00-00 Art. No. 247088



- Lamp: Flashing beacon – XENON (5 J) / continuous beacon – LED (6.5 W)
- Type of protection: Ex d
- Class: IP66/IP67 (IEC 60529 / NEMA 4X)
- Corrosion-resistant GRP enclosure
- Stainless steel protection cage included
- 8 light-intensifying Fresnel lens colours available to order
- Low weight (2.25 kg)

Webshop FX15A



Product series FX15 provides visual signals from a continuous beacon with an LED or a 5 J flashing beacon with xenon flashes. The enclosure is made of glass fibre reinforced polyester. The product series is intended for use in hazardous areas and harsh environments.

Technical Data

Explosion Protection

Scope of validity	IECEX European Union (ATEX)
Application range (zones)	1 2 21 22
IECEX gas certificate	IECEX BAS 13.0005X
IECEX gas explosion protection	Ex d IIB T6 Gb
IECEX dust certificate	IECEX BAS 13.0005X
IECEX dust explosion protection	Ex tb IIIC T85 °C Db
ATEX gas certificate	Baseefa 13 ATEX 0007X
ATEX gas explosion protection	⊕ II 2 G Ex d IIB T6 Gb
ATEX dust certificate	Baseefa 13 ATEX 0007X
ATEX dust explosion protection	⊕ II 2 D Ex tb IIIC T85 °C Db
Certificates	ATEX (BAS), IECEX (BAS)
Declaration of Conformity	ATEX (EUK)

Temperature class	Max. surface temperature T	Ambient temperature range
T6	85 °C	-60 °C ... +70 °C
		...
		...

Electrical Data

Rated operational voltage DC	24 V
Power	2.6 W
Tolerance	-10 – 10 %

Lighting Data

Lamp	LED
------	-----

Signalling Devices



Visual signalling device LED continuous beacon

In flameproof enclosure

FX15/B-D-060-R-EN-RN-A-ST-00-00-00 Art. No. 247088

Lighting Data

Effective luminous intensity	37 cd
Luminous flux	44 lm

Ambient Conditions

Ambient temperature	-60 °C ... +70 °C (T6)
Operating temperature	-60 °C ... +50 °C

Mechanical Data

Degree of protection (IP)	IP66
Degree of protection (IP) (IEC 60529)	IP66/IP67
Enclosure material	Polyester (GRP), Glass fibre reinforced
Enclosure colour	Red (RAL 3001)
Sealing material	Red silicone 70
Material dome	Polycarbonate, prismatic
Wire guard material	Stainless steel
Max. solid connection terminals	2.5 mm ²
Max. finely stranded connection terminals	2.5 mm ²
Type of connection cable	Solid Finely stranded
Width	137 mm
Height	239 mm
Length	148 mm
Lens colour	Red
Seal	O-ring seal
Weight	2.23 kg
Weight	4.92 lb

Mounting / Installation

Connection type	Screw terminal
Mounting part material	Stainless steel

Components

Drilled holes	3 x M20
Cable glands and entries	Can be ordered as accessories
Stopping plugs	3 x dust cap
Wire guard	Yes

Signalling Devices

Visual signalling device LED continuous beacon

In flameproof enclosure

FX15/B-D-060-R-EN-RN-A-ST-00-00-00 Art. No. 247088



Technical Drawings – Subject to Alterations

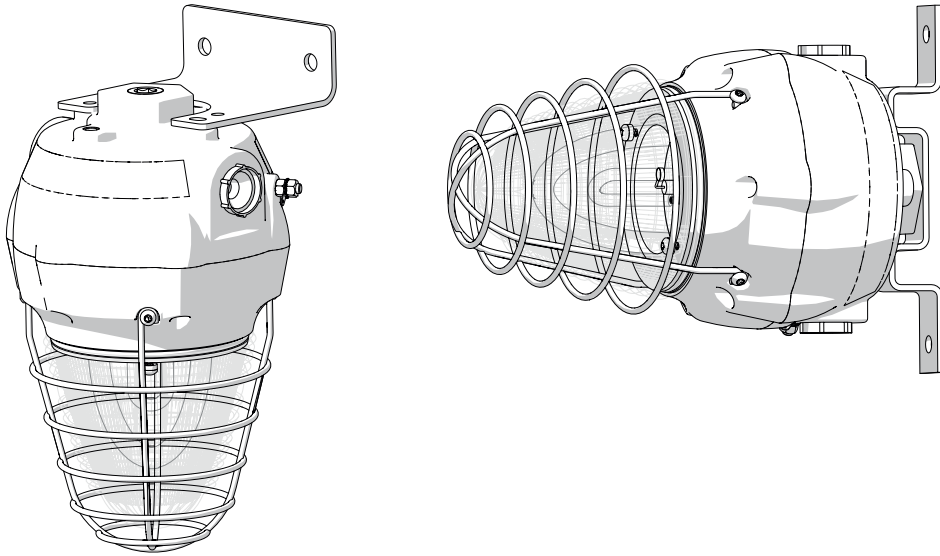

Dimensional Drawings (All Dimensions in mm [inches]) – Subject to Alterations

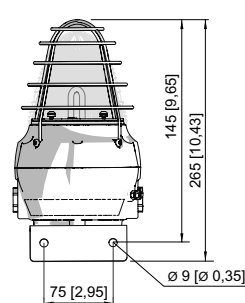
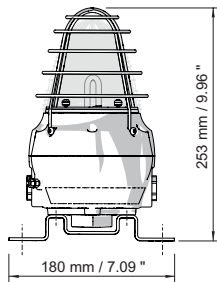
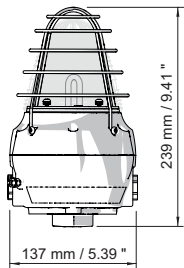
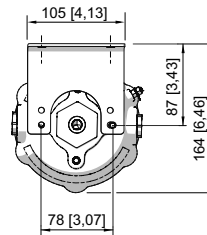
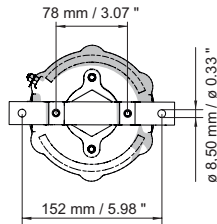
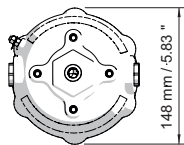

FX15 Beacon

FX15 Beacon with backstrap bracket

FX15 Beacon with L-bracket

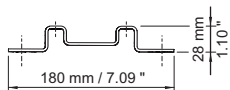
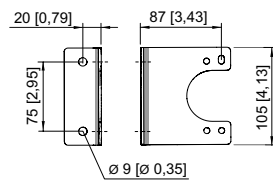
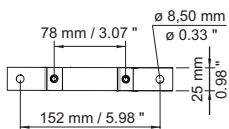

L-bracket

Backstrap bracket

Accessories

Metal cable gland

Art. No.

Signalling Devices



Visual signalling device LED continuous beacon

In flameproof enclosure

FX15/B-D-060-R-EN-RN-A-ST-00-00-00 Art. No. 247088

	Ex d & Ex e cable entry with compound for all types of armoured cables (SWA, braided, tape) (nickel-plated brass) Type 20PX2K, M20 x 1.5	109428
	Ex d & Ex e Cable entry with RapidEx sealing system for all types of unarmoured and braid armour cables (nickel-plated brass) Type 20PX2K-REX, M20 x 1.5	246649
	Ex d & Ex e Cable entry with compound gland for all types of unarmoured and braid armour cables (nickel plated brass) Type 20PXSS2K, M20 x 1.5	109441
	Ex d & Ex e Cable entry with RapidEx sealing system for all types of unarmoured and braid armour cables (nickel-plated brass) Type 20PXSS2K-REX, M20 x 1.5	246605
	Ex d & Ex e cable gland for all types of armoured cables (SWA, braided, tape) (nickel plated brass) with unique compensating displacement seal system (CDS) Type 20T3CDS, M20 x 1.5	246561

Stopping plugs

Art. No.

	Stopping plug made of stainless steel M20x1,5 with external hexagon	251101
--	---	--------

Mounting accessories

Art. No.

	Stainless steel L-bracket; standard – see dimensional drawings	221711
	Stainless steel L-bracket, long version	247371
	Stainless steel fastening bracket	221712
	Adapter plate for pipe clamp fastening	256519
	Stainless steel sun shield	262077
	Pipe clamp, R 1 1/4"	120812
	Pipe clamp, R 1 1/2"	120819
	Pipe clamp, R 2"	120823

Spare Parts

Flange

Art. No.

Signalling Devices



Visual signalling device LED continuous beacon

In flameproof enclosure

FX15/B-D-060-R-EN-RN-A-ST-00-00-00 Art. No. 247088



Flange, ATEX, red (available for FL6S, FX15, YL6S)

243408

We reserve the right to make alterations to the technical data, dimensions, weights, designs and products available without notice. The illustrations cannot be considered binding.