

Lighting

Linear luminaire With LED

GRP

6402/4148-9100-152-2220-22-8400 Art. No. 307338

STAHL



- State-of-the-art LED technology with high luminous efficacy and long service life
- Extremely high luminaire efficacy
- Luminous flux after 100,000 h still 90% of the starting luminous flux
- Optionally with DALI for controlling and monitoring the luminaire
- Optionally with address modules for directly actuation of a common battery system

MY R. STAHL 6402C



The linear luminaire with Series 6402/4 LED is ideal for lighting surfaces at a mounting height of up to 10 m. It can also be used to illuminate equipment and objects, both inside and outside. The pole mounting sleeve accessory can be used to easily mount the luminaire on poles. Optionally, the luminaire can be equipped with an address module. It can be used to control and monitor the luminaire for the common battery systems.

Technical Data

Explosion Protection

Ex version	Yes
Application range (zones)	2 21 22
IECEX gas certificate	IECEX IBE 14.0080
IECEX gas explosion protection	Ex ec IIC T4 Gc
IECEX dust certificate	IECEX IBE 14.0080
IECEX dust explosion protection	Ex tb op is / tc IIIC T100 °C Db
ATEX gas certificate	IBEx U 14 ATEX 1292
ATEX gas explosion protection	⊕ II 3 G Ex ec IIC T4 Gc
ATEX dust certificate	IBEx U 14 ATEX 1292
ATEX dust explosion protection	⊕ II 2 D Ex tb op is / tc IIIC T100 °C Db
Certificates and approvals	ATEX IECEX UKEX
Certificates	ATEX (IBE), IECEX (IBE)
Declaration of Conformity	ATEX (EUK), Declaration of Conformity (AUS)

Electrical Data

Rated operational voltage AC	220 – 240 V
Rated operational voltage DC	196 ... 250 V
Frequency range	50 – 60 Hz

Lighting Data

Number of lamps	1
Lamp wattage	42 W
Lamp	LED
Light colour	4000 K – warm neutral white
Light distribution	120°x120° with diffusing glass

Lighting

Linear luminaire With LED

GRP

6402/4148-9100-152-2220-22-8400 Art. No. 307338



Lighting Data

Luminaire efficacy	138 lm/W
Luminous flux	5810 lm
Colour rendering	≥ 80
Colour temperature	4000 K

Ambient Conditions

Ambient temperature	-40 °C ... +50 °C (T100 °C) Note: Through wiring Max. 3x16 A -40 °C ... +55 °C (T100 °C) Note: Through wiring 2 Max. 3x10 A
---------------------	--

Mechanical Data

Version	Standard
IP degree of protection (IEC 60598)	IP66/IP67
Enclosure material	Polyester resin, Glass fibre reinforced
Enclosure colour	Light grey (RAL 7035)
Diffuser	With diffuser
Sealing material	Silicone
Silicone-free content	Contains silicone
Translucent cover material	Polycarbonate
Installed terminal strip	PE + N + L1 + L2 + L3
Max. solid connection terminals	6 mm ²
Max. finely stranded connection terminals	4 mm ²
Type of connection cable	Finely stranded Solid
Size	4
Width	184 mm
Height	125 mm
Length	1310 mm
Impact strength (IEC 62262)	IK10
Weight	5.6 kg
Weight	12.35 lb
Disconnection of the luminaire	No

Components

Threaded plate	2x SS430 stainless steel
Ballast	CG Luxtronic 48 W 300mA (91)
Through wiring	With 5 conductors 2.5 mm ²
Drilled holes	3 x M20
Cable glands and entries	Can be ordered as accessories
Stopping plugs	Can be ordered as accessories
Accessories	without

Light Distribution Curves

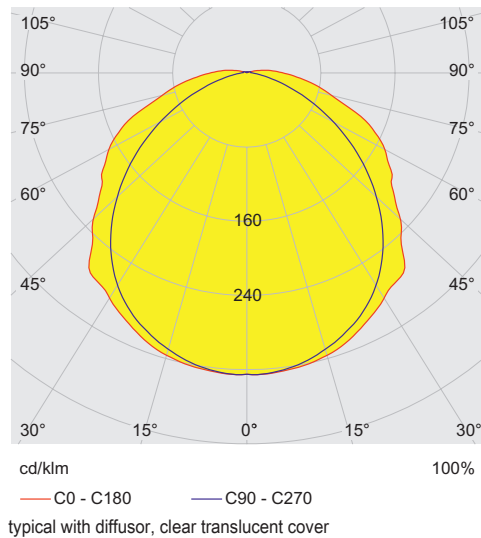

Dimensional Drawings (All Dimensions in mm [inches]) – Subject to Alterations

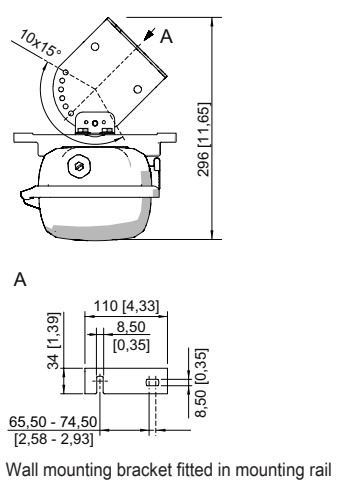
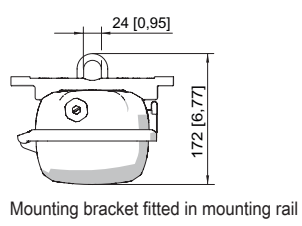
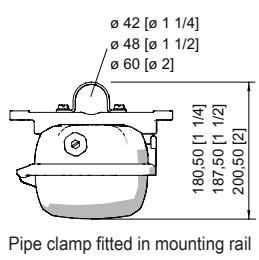
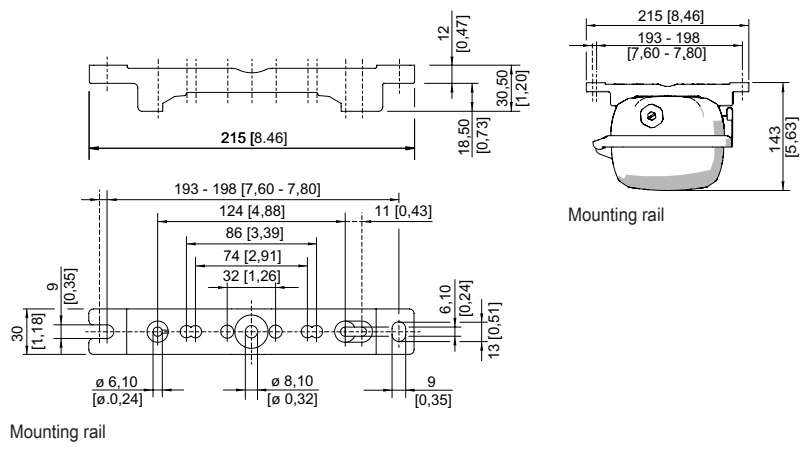
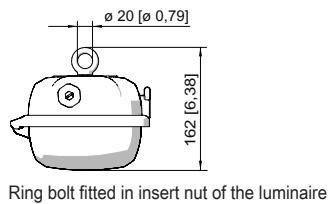

Accessories

Breather

Art. No.

Lighting

Linear luminaire With LED

GRP

6402/4148-9100-152-2220-22-8400 Art. No. 307338

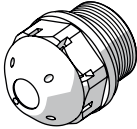
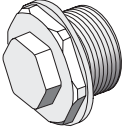

	Thread: M25 x 1.5 (20 pieces); without jam nut	285780
	Thread: M25 x 1.5 (1 piece); for installation in light fittings; made from stainless steel; without jam nut	296608

Holder for translucent cover

Art. No.

	The fall prevention system for the light fitting cover prevents the light fitting cover from falling accidentally when the light fitting is opened.	226791
--	---	--------

We reserve the right to make alterations to the technical data, dimensions, weights, designs and products available without notice. The illustrations cannot be considered binding.