

Lighting

Linear luminaire With LED

GRP

6402/4128-9100-150-2220-22-8750 Art. No. 311193



- State-of-the-art LED technology with high luminous efficacy and long service life
- Extremely high luminaire efficacy
- Luminous flux after 100,000 h still 90% of the starting luminous flux
- Optionally with DALI for controlling and monitoring the luminaire
- Optionally with address modules for directly actuation of a common battery system

MY R. STAHL 6402C



The linear luminaire with Series 6402/4 LED is ideal for lighting surfaces at a mounting height of up to 10 m. It can also be used to illuminate equipment and objects, both inside and outside. The pole mounting sleeve accessory can be used to easily mount the luminaire on poles. Optionally, the luminaire can be equipped with an address module. It can be used to control and monitor the luminaire for the common battery systems.

Technical Data

Explosion Protection

Ex version	Yes
Application range (zones)	2, 21, 22
IECEX gas certificate	IECEX IBE 14.0080
IECEX gas explosion protection	Ex ec IIC T4 Gc
IECEX dust certificate	IECEX IBE 14.0080
IECEX dust explosion protection	Ex tb op is / tc IIIC T100 °C Db
ATEX gas certificate	IBExU 14 ATEX 1292
ATEX gas explosion protection	⊕ II 3 G Ex ec IIC T4 Gc
ATEX dust certificate	IBExU 14 ATEX 1292
ATEX dust explosion protection	⊕ II 2 D Ex tb op is / tc IIIC T100 °C Db
Certificates and approvals	ATEX IECEX UKEX
Certificates	ATEX (IBE), IECEX (IBE)
Declaration of conformity	ATEX (EUK), Declaration of Conformity (AUS)

Electrical Data

Rated operational voltage AC	220 ... 240 V
Rated operational voltage DC	196 ... 250 V
Frequency range	50 – 60Hz
Control gear service life	C10 ≥ 100 h, Ta ≤ 40 °C
LED service life	L90B50 ≥ 100 h

Lighting Data

Number of lamps	1
Lamp wattage	22 W
Lamp	LED
Light colour	5700 K – cool white

Lighting

Linear luminaire With LED

GRP

6402/4128-9100-150-2220-22-8750 Art. No. 311193



Lighting Data

Light distribution	120°x120° with diffusing glass
Luminaire efficacy	132 lm/W
Luminous flux	2910 lm
Colour rendering	≥ 80
Colour temperature	5700 K

Ambient Conditions

Ambient temperature	-40 °C ... 50 °C (T100 °C) Note: Through wiring Max. 3x16 A -40 °C ... 55 °C (T100 °C) Note: Through wiring 2 Max. 3x10 A
---------------------	--

Mechanical Data

Version	Standard
IP degree of protection (IEC 60598)	IP66/IP67
Enclosure material	Polyester resin, Glass fibre reinforced
Enclosure colour	Light grey (RAL 7035)
Material insert nut	brass
Diffuser	With diffuser
Sealing material	Silicone
Silicone-free content	Contains silicone
Translucent cover material	Polycarbonate
Installed terminal strip	PE + N + L1 + L2 + L3
Max. solid connection terminals	6 mm ²
Max. finely stranded connection terminals	4 mm ²
Type of connection cable	Finely stranded Solid
Size	2
Width	184 mm
Height	125 mm
Length	700 mm
Impact strength (IEC 62262)	IK10
Weight	3.3 kg
Weight	7.28 lb
Disconnection of the luminaire	No

Components

Threaded plate	2x SS430 stainless steel
Ballast	CG Luxtronic 48 W 300mA (91)
Through wiring	without
Drilled holes	3 x M20
Cable glands and entries	can be ordered as an accessory
Stopping plugs	Can be ordered as accessories
Accessories	without

Lighting

Linear luminaire With LED

GRP

6402/4128-9100-150-2220-22-8750 Art. No. 311193



Dimensional Drawings (All Dimensions in mm [inches]) – Subject to Alterations

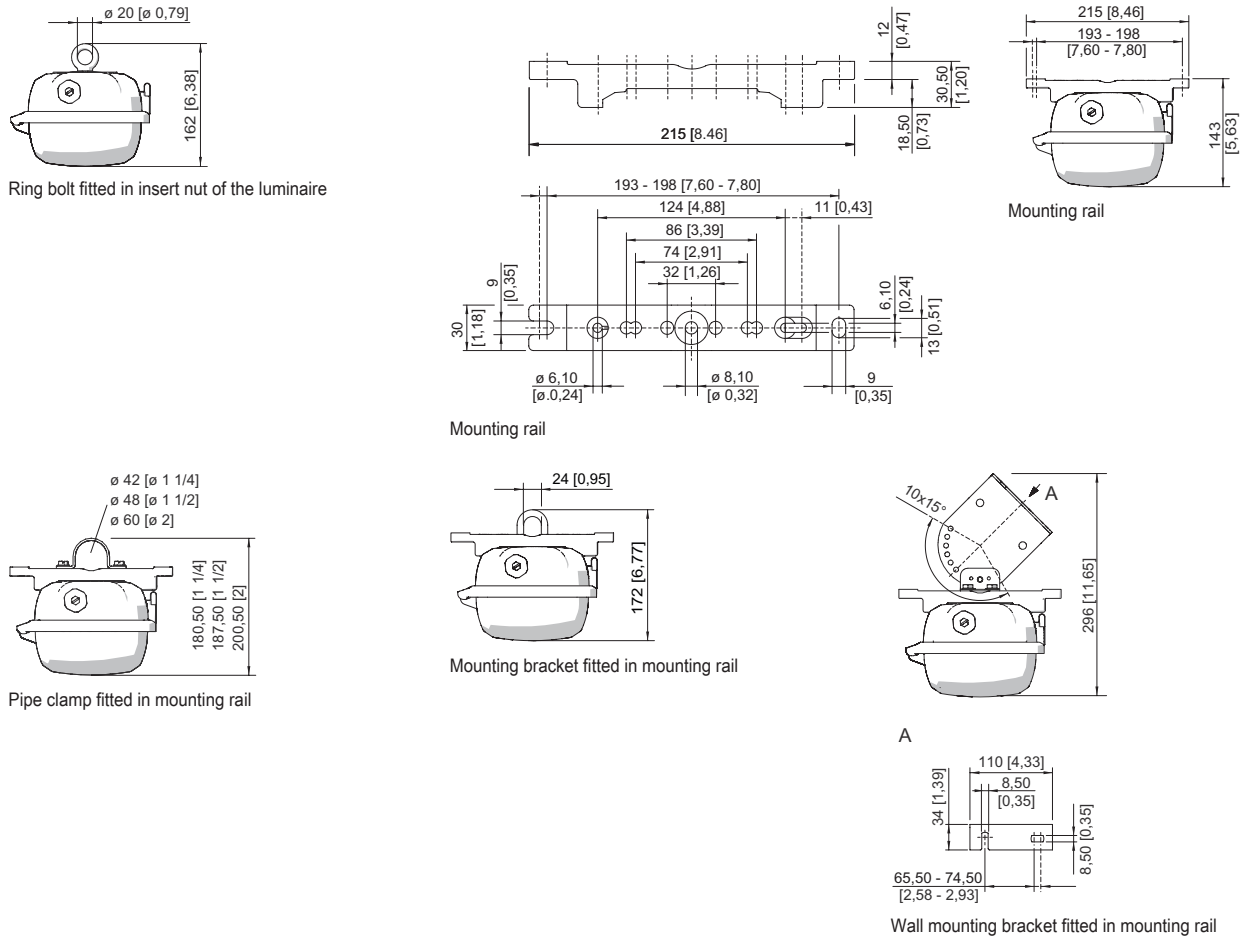

Accessories

Pole mounting sleeve



for the subsequent mounting on lights size 2 and size 4, completely with assembly parts (for pipe diameter 42 mm)

Art. No.

227512

Adapter plate for mounting EXLUX 6002 on EXLUX 6000 mounting interfaces

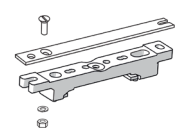

Adapter plate for installation of EXLUX 6002 luminaires onto EXLUX 6000 interfaces

Art. No.

240653

Protection against accidental contact

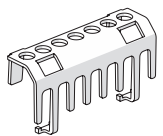

The protection against accidental contact prevents maintenance technicians and electrical installers from accidentally touching conductive parts. The degree of protection is increased to IP20 when the protection against accidental contact is used.

Art. No.

283153

Lighting

Linear luminaire With LED

GRP

6402/4128-9100-150-2220-22-8750 Art. No. 311193



Fall protection

Art. No.

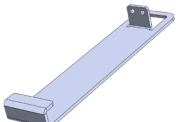
	Accessories for mounting an arrester cable	295927
--	--	--------

Holder for translucent cover

Art. No.

	The fall prevention system for the light fitting cover prevents the light fitting cover from falling accidentally when the light fitting is opened.	226791
--	---	--------

Breather

Art. No.

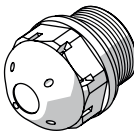
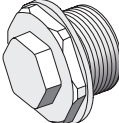
	Thread: M25 x 1.5 (20 pieces); without jam nut	285780
	M25 x 1.5 in order to avoid condensate formation	115738
	Thread: M20 x 1.5 (1 piece); for installation in light fittings; made from stainless steel; without jam nut	323702
	Thread: M25 x 1.5 (1 piece); for installation in light fittings; made from stainless steel; without jam nut	296608

Mounting bracket

Art. No.

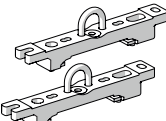
	mounting clamp mounted on a mounting rail for a variable mounting distance; 1 pair	222456
--	--	--------

Mounting rail

Art. No.

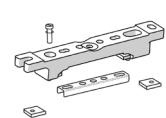
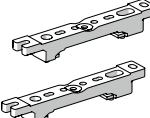
	Mounting accessories for ceiling mounting of EXLUX luminaires with V4A metal insert for reinforcement	325835
	Mounting accessories for ceiling mounting of EXLUX luminaires with V4A metal insert and captive M8 nut	329336
	for a variable mounting distance; 1 pair	222826

Ring bolt

Art. No.

	M8, direct mounting in insert nuts; 1 pair	115736
--	--	--------

Pipe clamp

Art. No.

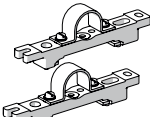
	R 1 1/2"; with mounting rail for a variable mounting distance; material: stainless steel; 1 pair	222459
	R 1 1/4"; with mounting rail for a variable mounting distance; Material: stainless steel; 1 pair	222458
	R 2"; with mounting rail for a variable mounting distance; Material: stainless steel; 1 pair	222460

Lighting

Linear luminaire With LED

GRP

6402/4128-9100-150-2220-22-8750 Art. No. 311193



Box spanner

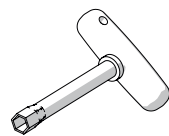

M8 / A/F 13;
For actuating the central lock

Art. No.

222430

Ceiling and wall mounting bracket

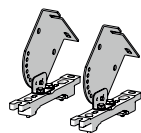

mounted on a mounting rail for a variable mounting distance; Material: stainless steel; Lamp can be swiveled in steps of 15°; 1 pair

Art. No.

222827

We reserve the right to make alterations to the technical data, dimensions, weights, designs and products available without notice. The illustrations cannot be considered binding.