

# Lighting

## Linear luminaire With LED

GRP

6402/4168-6200-152-LLL2-22-8500 Art. No. 316815



- State-of-the-art LED technology with high luminous efficacy and long service life
- Extremely high luminaire efficacy
- Luminous flux after 100,000 h still 90% of the starting luminous flux
- Optionally with DALI for controlling and monitoring the luminaire
- Optionally with address modules for directly actuation of a common battery system

MY R. STAHL 6402C



The linear luminaire with Series 6402/4 LED is ideal for lighting surfaces at a mounting height of up to 10 m. It can also be used to illuminate equipment and objects, both inside and outside. The pole mounting sleeve accessory can be used to easily mount the luminaire on poles. Optionally, the luminaire can be equipped with an address module. It can be used to control and monitor the luminaire for the common battery systems.

### Technical Data

#### Explosion Protection

Ex version	Yes
Application range (zones)	2, 22
IECEX gas certificate	IECEX IBE 14.0080
IECEX gas explosion protection	Ex ec IIC T4 Gc
IECEX dust certificate	IECEX IBE 14.0080
IECEX dust explosion protection	Ex tb op is IIIC T100 °C Db Ex tc IIIC T100 °C Dc
ATEX gas certificate	IBExU 14 ATEX 1292
ATEX gas explosion protection	⊕ II 3 G Ex ec IIC T4 Gc
ATEX dust certificate	IBExU 14 ATEX 1292
ATEX dust explosion protection	⊕ II 2 D Ex tb op is IIIC T100 °C Db ⊕ II 3 D Ex tc IIIC T100 °C Dc
Certificates and approvals	ATEX IECEX
Certificates	ATEX (IBE), IECEX (IBE)
Declaration of conformity	ATEX (EUK)

#### Electrical Data

AC rated operational voltage	220 ... 240 V
DC rated operational voltage	200 ... 250 V
Frequency	50 ... 60 Hz
Control gear service life	C10 ≥ 100 h, Ta ≤ 50 °C
LED service life	L90B50 ≥ 100 h

#### Lighting Data

Number of lamps	1
Lamp wattage	49 W
Lamp	LED

# Lighting

## Linear luminaire With LED

### GRP

6402/4168-6200-152-LLL2-22-8500 Art. No. 316815



#### Lighting Data

Light colour	5000 K – neutral white
Light distribution	120°x120° with diffusing glass
Luminaire efficacy	163 lm/W
Luminous flux	7920 lm
Colour rendering	≥ 80
Colour temperature	5000 K

#### Ambient Conditions

Ambient temperature	-20 °C ... 55 °C (Through wiring max. 3x16 A) -20 °C ... 60 °C (Through wiring max. 3x10 A)
---------------------	--

#### Mechanical Data

Version	Standard
IP degree of protection (IEC 60598)	IP66
Enclosure material	Polyester resin, Glass fibre reinforced
Enclosure colour	Light grey (RAL 7035)
Insert nut material	Brass
Diffuser	With diffuser
Sealing material	Silicone
Silicone-free content	Contains silicone
Translucent cover material	Polycarbonate
Installed terminal strip	PE + N + L1 + L2 + L3
Max. solid connection terminals	6 mm <sup>2</sup>
Max. finely stranded connection terminals	4 mm <sup>2</sup>
Type of connection cable	Finely stranded Solid
Size	6
Width	184 mm
Height	125 mm
Length	1610 mm
Impact strength (IEC 62262)	IK10
Disconnection of the luminaire	No
Weight	7 kg
Weight	15.43 lb

#### Components

Threaded plate	2x SS430 stainless steel
Ballast	VG Luxtronic 80 W 350 mA
Through wiring	With 5 conductors 2.5 mm <sup>2</sup>
Drilled holes	4 x M20
Cable glands and entries	can be ordered as an accessory
Stopping plugs	3 x M20 x 1.5
Stopping plug material	Polyamide, black
Accessories	Installed

# Lighting

## Linear luminaire With LED

### GRP

6402/4168-6200-152-LLL2-22-8500 Art. No. 316815



#### Dimensional Drawings (All Dimensions in mm [inches]) – Subject to Alterations

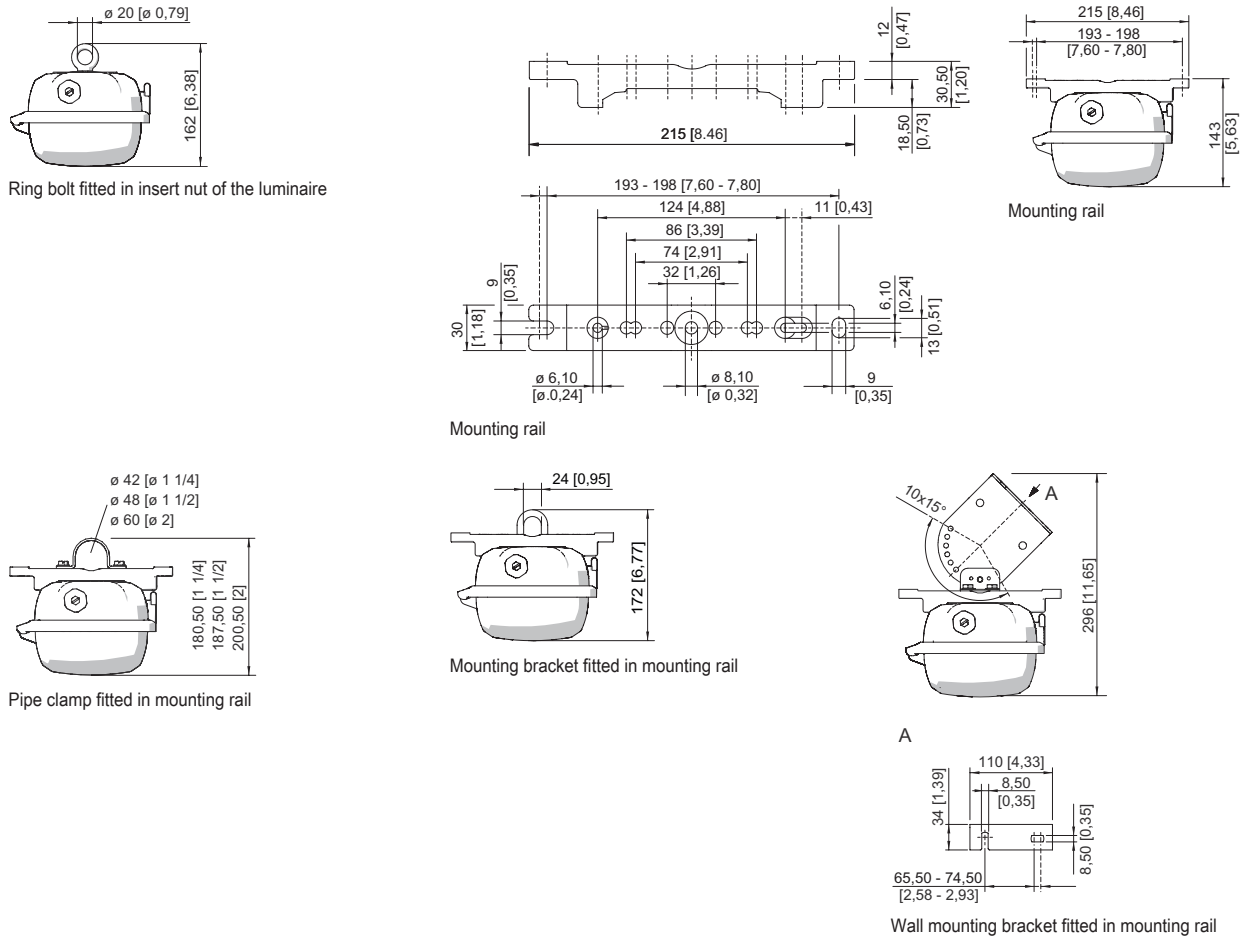

## Accessories

Adapter plate for mounting EXLUX 6002 on EXLUX 6000 mounting interfaces		Art. No.
	Adapter plate for installation of EXLUX 6002 luminaires onto EXLUX 6000 interfaces	240653
Protection against accidental contact		Art. No.
	The protection against accidental contact prevents maintenance technicians and electrical installers from accidentally touching conductive parts. The degree of protection is increased to IP20 when the protection against accidental contact is used.	283153
Fall protection		Art. No.
	Accessories for mounting an arrester cable	295927

#### Holder for translucent cover

Art. No.



The fall prevention system for the light fitting cover prevents the light fitting cover from falling accidentally when the light fitting is opened.

226791

#### Breather

Art. No.

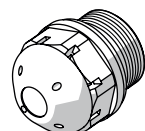

Thread: M25 x 1.5 (20 pieces); without jam nut

285780

M25 x 1.5 in order to avoid condensate formation

115738

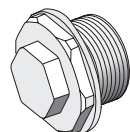

Thread: M20 x 1.5 (1 piece); for installation in light fittings; made from stainless steel; without jam nut

323702

Thread: M25 x 1.5 (1 piece); for installation in light fittings; made from stainless steel; without jam nut

296608

#### Mounting bracket

Art. No.

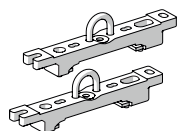

mounting clamp mounted on a mounting rail for a variable mounting distance; 1 pair

222456

#### Mounting rail

Art. No.

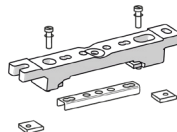

Mounting accessories for ceiling mounting of EXLUX luminaires with V4A metal insert for reinforcement

325835

Mounting accessories for ceiling mounting of EXLUX luminaires with V4A metal insert and captive M8 nut

329336

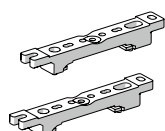

for a variable mounting distance; 1 pair

222826

#### Ring bolt

Art. No.



M8, direct mounting in insert nuts; 1 pair

115736

#### Pipe clamp

Art. No.

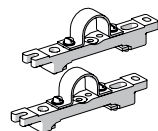

R 1 1/2"; with mounting rail for a variable mounting distance; material: stainless steel; 1 pair

222459

R 1 1/4"; with mounting rail for a variable mounting distance; Material: stainless steel; 1 pair

222458

R 2"; with mounting rail for a variable mounting distance; Material: stainless steel; 1 pair

222460

#### Box spanner

Art. No.

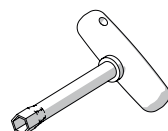

M8 / A/F 13;  
For actuating the central lock

222430

# Lighting

Linear luminaire With LED

GRP

6402/4168-6200-152-LLL2-22-8500 Art. No. 316815



## Ceiling and wall mounting bracket

Art. No.

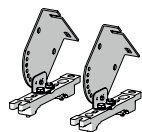

mounted on a mounting rail for a variable mounting distance; Material: stainless steel; Lamp can be swiveled in steps of 15°; 1 pair

222827

## Spare Parts

### Cover

Art. No.

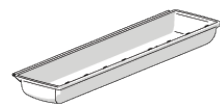

for luminaire size 6

222429

### Reflector plate

Art. No.

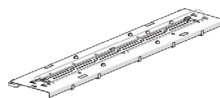

Spare part for 6402 or upgrade 6401 size 6, colour temperature 5000 K

276765

We reserve the right to make alterations to the technical data, dimensions, weights, designs and products available without notice. The illustrations cannot be considered binding.