

# Lighting

## Emergency luminaire With LED

GRP

L409/4328-5103-162-LLL2-22-850011 Art. No. 316816



- Long-lasting LED version of the EXLUX family in an industrial design
- Robust, durable enclosure with central lock for use as humid lighting
- Integrated, automatically started test function for the integrated battery
- Up to 3 hours battery runtime with a luminous flux of 1000 lm in emergency operation
- Available with warm white, neutral white and cold white colour temperatures

### MY R. STAHL L409A

The EXLUX L409/4 light fitting completes the LED linear luminaire range. The industrial design of the emergency luminaires offers all the advantages of the robust enclosure technology and long-lasting LED technology for which the EXLUX range is known. This automatically starts all test functions set out as mandatory in standards and the ergonomic light fitting device provides clear signals. The entire range of installation material for the EXLUX family is also available.

### Technical Data

Explosion Protection	
Ex version	Industrial design
Declaration of conformity	ATEX (EUK)
Electrical Data	
AC rated operational voltage	110 ... 240 V
Frequency	50 ... 60 Hz
Battery version	NiCd battery, gas-tight
Battery operating voltage	6 V
Battery capacity	7 Ah
Self-test function	With (standard)
Control gear service life	C10 ≥ 100 h, Ta ≤ 60 °C
LED service life	L90B50 ≥ 100 h
Lighting Data	
Number of lamps	1
Lamp wattage	21 W
Lamp	LED
Light colour	5000 K – neutral white
Light distribution	120°x120° with diffusing glass
Luminaire efficacy	141 lm/W
Luminous flux	2890 lm
Operating time	1.5h emergency lighting operation
Emergency light output	65% – 1.5 h
Colour rendering	≥ 80
Ambient Conditions	
Ambient temperature	-30 °C ... 50 °C (Through wiring max. 3x16 A) -30 °C ... 55 °C (Through wiring max. 3x10 A)

# Lighting

## Emergency luminaire With LED

### GRP

L409/4328-5103-162-LLL2-22-850011 Art. No. 316816



#### Ambient Conditions

Ambient temperature	-22 °F ... 122 °F (Through wiring max. 3x16 A) -22 °F ... 131 °F (Through wiring max. 3x10 A)
---------------------	--

#### Mechanical Data

Version	Standard
IP degree of protection (IEC 60598)	IP66/IP67
Enclosure material	Polyester resin, Glass fibre reinforced
Enclosure colour	Light grey (RAL 7035)
Insert nut material	Brass
Diffuser	With diffuser
Sealing material	Silicone
Silicone-free content	Contains silicone
Translucent cover material	Polycarbonate
Installed terminal strip	PE + N + L1 + L2 + L3 + L'
Max. solid connection terminals	6 mm <sup>2</sup>
Max. finely stranded connection terminals	4 mm <sup>2</sup>
Type of connection cable	Finely stranded Solid
Size	2
Width	183.5 mm
Height	125 mm
Length	857 mm
Impact strength (IEC 62262)	IK10
Disconnection of the luminaire	All-pole disconnection
Weight	5.4 kg
Weight	11.9 lb

#### Components

Threaded plate	2x SS430 stainless steel
Ballast	LED NLE 80W 110-240V/7Ah/1.5h/
Through wiring	With 6 conductors 2.5 mm <sup>2</sup>
Drilled holes	4 x M20
Cable glands and entries	can be ordered as an accessory
Stopping plugs	3 x M20 x 1.5
Stopping plug material	Polyamide, black
Accessories	Installed

# Lighting

## Emergency luminaire With LED

### GRP

L409/4328-5103-162-LLL2-22-850011 Art. No. 316816



#### Dimensional Drawings (All Dimensions in mm [inches]) – Subject to Alterations

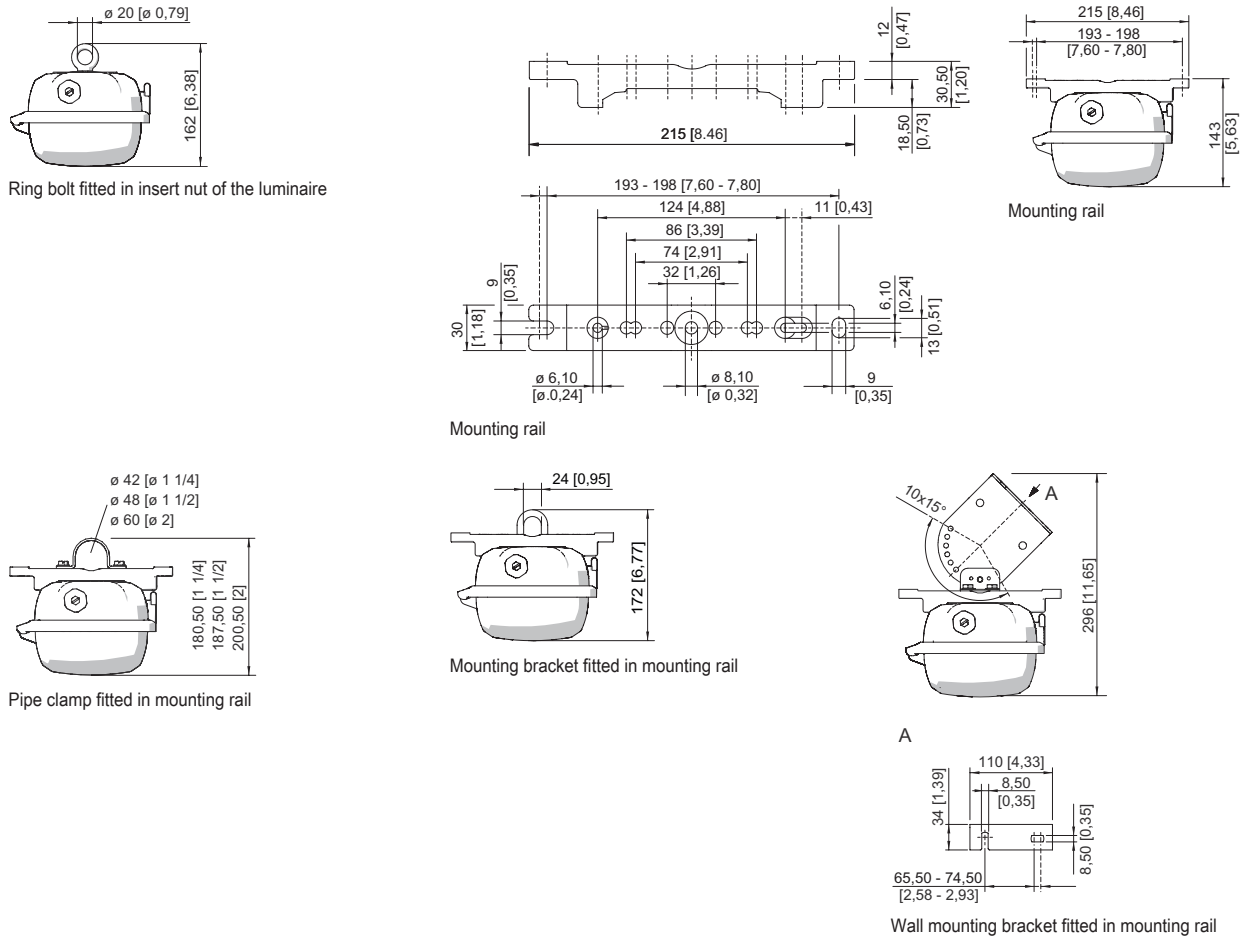

## Accessories

		Art. No.
	Adapter plate for installation of EXLUX 6002 luminaires onto EXLUX 6000 interfaces	240653
	M8 / A/F 13; For actuating the central lock	222430
	Thread: M25 x 1.5 (20 pieces); without jam nut	285780
	Thread: M20 x 1.5 (1 piece); for installation in light fittings; made from stainless steel; without jam nut	323702
	Thread: M25 x 1.5 (1 piece); for installation in light fittings; made from stainless steel; without jam nut	296608

# Lighting

## Emergency luminaire With LED

GRP

L409/4328-5103-162-LLL2-22-850011 Art. No. 316816

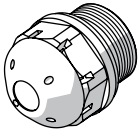
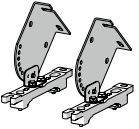
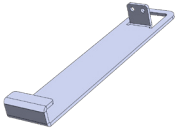
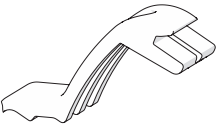
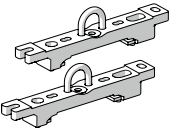
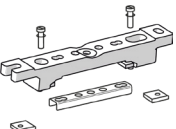
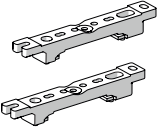
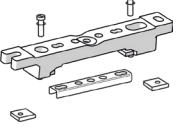
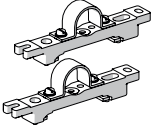

Breather		Art. No.
	M25 x 1.5 in order to avoid condensate formation	115738
Ceiling and wall mounting bracket		Art. No.
	mounted on a mounting rail for a variable mounting distance; Material: stainless steel; Lamp can be swiveled in steps of 15°; 1 pair	222827
Fall protection		Art. No.
	Accessories for mounting an arrester cable	295927
Holder for translucent cover		Art. No.
	The fall prevention system for the light fitting cover prevents the light fitting cover from falling accidentally when the light fitting is opened.	226791
Mounting bracket		Art. No.
	mounting clamp mounted on a mounting rail for a variable mounting distance; 1 pair	222456
Mounting rail		Art. No.
	Mounting accessories for ceiling mounting of EXLUX luminaires with V4A metal insert for reinforcement	325835
	for a variable mounting distance; 1 pair	222826
	Mounting accessories for ceiling mounting of EXLUX luminaires with V4A metal insert and captive M8 nut	329336
Pipe clamp		Art. No.
	R 1 1/2"; with mounting rail for a variable mounting distance; material: stainless steel; 1 pair	222459
	R 1 1/4"; with mounting rail for a variable mounting distance; Material: stainless steel; 1 pair	222458
	R 2"; with mounting rail for a variable mounting distance; Material: stainless steel; 1 pair	222460

# Lighting

Emergency luminaire With LED

GRP

L409/4328-5103-162-LLL2-22-850011 Art. No. 316816



## Pole mounting sleeve

Art. No.

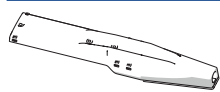

for the subsequent mounting on lights size 2 and size 4, completely with assembly parts (for pipe diameter 42 mm)

227512

## Protection against accidental contact

Art. No.

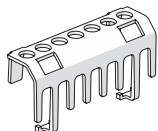

The protection against accidental contact prevents maintenance technicians and electrical installers from accidentally touching conductive parts. The degree of protection is increased to IP20 when the protection against accidental contact is used.

283153

## Spare Parts

### Cover

Art. No.

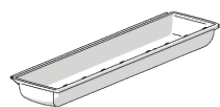

for luminaire size 2

222427

### Contact element

Art. No.

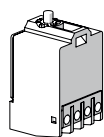

8080/1-3-L 2 NC contact element

132527

### Battery set

Art. No.

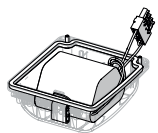

Battery cover with built-in battery. Gas-tight NiCd battery; 7 Ah / 6 V

223532

We reserve the right to make alterations to the technical data, dimensions, weights, designs and products available without notice. The illustrations cannot be considered binding.