

Signalling devices

Visual signalling device XENON light fitting

In flameproof enclosure

FL60/324-D0111-00BW30-ST000-0000 Art. No. 319349



- The latest generation of audible and visual alarm devices
- Ex d/Ex e connection chambers
- Visual solutions with 5 to 21 J XENON and high-power LEDs with various light modes and 4 light channels
- Four output levels can be configured
- Brackets, fixings and protective grid made from stainless steel
- Compliant with EN 54/DNV
- Fastening bracket and protective cage included

MY R. STAHL FL60D



The **FL60/3 product series** provides visual alarm signals which can be used to alert, warn or draw attention to equipment malfunction/start-up or any number of safety-related issues in hazardous areas. The preconfigured light patterns (LED) provide a wide range of internationally standardised signal patterns, whereby four channels are available for each, enabling flexible use. The signalling devices meet the requirements of EN 54 and DNV for extremely challenging ambient conditions.

Technical Data

Explosion Protection

Scope of validity	European Union (ATEX) IECEX United Kingdom
Application range (zones)	1 2 21 22
IECEX gas certificate	IECEX EPS 22.0046X
IECEX gas explosion protection	Ex db eb IIC T4 Gb
IECEX dust certificate	IECEX EPS 22.0046X
IECEX dust explosion protection	Ex tb IIIC T100 °C Db
ATEX gas certificate	EPS 22 ATEX 1 224X
ATEX gas explosion protection	⊕ II 2 G Ex db eb IIC T4 Gb
ATEX dust certificate	EPS 22 ATEX 1 224X
ATEX dust explosion protection	⊕ II 2 D Ex tb IIIC T100 °C Db
Certificates	ATEX (BVIS), IECEX (BVIS)
Declaration of Conformity	ATEX (EUK)

Electrical Data

Rated operational voltage DC	12 ... 27.2 V
Line monitoring	Yes
Tolerance	-10 ... 10 %

Lighting Data

Lamp	5 J xenon flash tubes
Effective luminous intensity (1 Hz, flashing)	25 cd

Ambient Conditions

Ambient temperature	-40 °C ... 60 °C (T4)
---------------------	-----------------------

Signalling devices

Visual signalling device XENON light fitting

In flameproof enclosure

FL60/324-D0111-00BW30-ST000-0000 Art. No. 319349



Ambient Conditions

Storage temperature	-60 °C ... 70 °C
---------------------	------------------

Mechanical Data

IP degree of protection (IEC 60598)	IP66/67
Connection chamber version	Ex e
Enclosure material	Aluminium, powder-coated, Seawater-resistant
Enclosure colour	red, similar to RAL 3020
Silicone-free content	Contains silicone
Material dome	Polycarbonate, prismatic
Material glass dome	Polycarbonate, prismatic
Protective collar material	Polycarbonate (PC cover)
Wire guard material	Stainless steel
Max. solid connection terminals	4 mm ²
Max. finely stranded connection terminals	2.5 mm ²
Clamping range	0.5 ... 4 mm
Width	176 mm
Height	317 mm
Length	128 mm
Lens colour	Blue
Fastening	Wall bracket
Weight	5.51 kg
Weight	12.14 lb

Mounting / Installation

Connection type	Push in
Mounting part material	Stainless steel

Components

Drilled holes	2 x M20 + 2 x M25
Cable glands and entries	1 x M20 Ø 4 ... 13 mm 1 x M25 Ø 7 ...
Material cable gland	Polyamide, black
Stopping plugs	2x M20 + 2x M25
Stopping plug material	Polyamide, black

Signalling devices

Visual signalling device XENON light fitting

In flameproof enclosure

FL60/324-D0111-00BW30-ST000-0000 Art. No. 319349



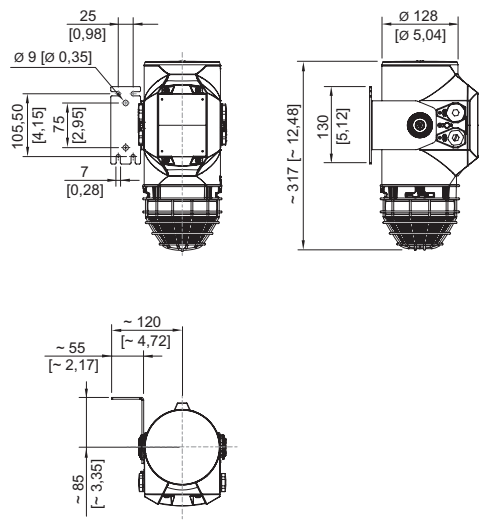

Dimensional Drawings (All Dimensions in mm [inches]) – Subject to Alterations



Accessories

Metal cable gland

		Art. No.
	Ex d and Ex e cable gland with compound for all types of armoured cables (SWA, wire-braid, tape) (nickel-plated brass) Type 20PX2K, M20 x 1.5	109428
	Ex d and Ex e cable glands with RapidEx sealing system for all types of unarmoured cables and wire-braid-armoured cables (nickel-plated brass) Type 20PX2K-REX, M20 x 1.5	246649
	Ex d and Ex e cable glands with compound for all types of unarmoured cables and wire-braid-armoured cables (nickel-plated brass) Type 20PXSS2K, M20 x 1.5	109441
	Ex d and Ex e cable glands with RapidEx sealing system for all types of unarmoured cables and wire-braid-armoured cables (nickel-plated brass) Type 20PXSS2K-REX, M20 x 1.5	246605

Cable gland made of plastic

		Art. No.
	8161/7-M20-1304, Ex e Plastic, M20 x 1.5, cable outer diameter 4 to 13 mm Lot size 50 pieces	239156

Stopping plug

		Art. No.
	8290/3-M20 Plastic, M20 x 1.5 Lot size 1 piece	143522
	8290/3-M20 Plastic, M20 x 1.5 Lot size 100 pieces	285773

Mounting accessories

		Art. No.
	L-bracket, stainless steel 1.4404	319271

Signalling devices



Visual signalling device XENON light fitting

In flameproof enclosure

FL60/324-D0111-00BW30-ST000-0000 Art. No. 319349

	U-bracket, stainless steel 1.4404	319280
--	-----------------------------------	--------

Protective cage

Art. No.

	Protective cage, stainless steel 1.4404	319272
--	---	--------

Spare Parts

Textured lens

Art. No.

	blue	319274
--	------	--------

Lamp

Art. No.

	Xenon tube PCB 5 joules	319281
--	-------------------------	--------

We reserve the right to make alterations to the technical data, dimensions, weights, designs and products available without notice. The illustrations cannot be considered binding.