

Signalling devices

Audible/visual signal. device Horn/XENON light fitting

In flameproof enclosure

YL60/324-PL101-00BW30-ST000-0000 Art. No. 319433



- The latest generation of audible and visual alarm devices
- Ex d/Ex e connection chambers
- Visual solutions with 5 to 21 J XENON and high-power LEDs with various light modes and 4 light channels
- Audible solutions with directional or omnidirectional horn with up to 120 dB(A) at 1 m, 4 tone channels and 64 preconfigured tones
- Four output levels can be configured
- Brackets, fixings and protective grid made from stainless steel
- Compliant with EN 54/DNV
- Fastening bracket and protective cage included

MY R. STAHL YL60C



The **YL60/3 product series** provides audible and visual alarm signals which can be used to alert, warn or draw attention to equipment malfunction/start-up or any number of safety-related issues in hazardous areas. The preconfigured signal tones and light patterns (LED) provide a wide range of internationally standardised signal patterns. The audible and visual signals can be operated separately or in combination, with four channels available for each type of signal, enabling flexible use. The signalling devices meet the requirements of EN 54 and DNV for extremely challenging ambient conditions.

Technical Data

Explosion Protection

| | |
|---------------------------------|--|
| Area of application | European Union (ATEX) IECEX United Kingdom |
| Application range (zones) | 1, 2, 21, 22 |
| IECEX gas certificate | IECEX EPS 22.0046X |
| IECEX gas explosion protection | Ex db eb IIC T4 Gb |
| IECEX dust certificate | IECEX EPS 22.0046X |
| IECEX dust explosion protection | Ex tb IIIC T100 °C Db |
| ATEX gas certificate | EPS 22 ATEX 1 224X |
| ATEX gas explosion protection | ⊕ II 2 G Ex db eb IIC T4 Gb |
| ATEX dust certificate | EPS 22 ATEX 1 224X |
| ATEX dust explosion protection | ⊕ II 2 D Ex tb IIIC T100 °C Db |
| Certificates | ATEX (BVIS), IECEX (BVIS) |
| Declaration of Conformity | ATEX (EUK) |

Electrical Data

| | |
|------------------------------|---------------|
| Rated operational voltage AC | 110 ... 240 V |
| Rated operational voltage DC | 133 ... 272 V |
| Line monitoring | Yes |
| Tolerance | -10 ... 10 % |
| Frequency range | 50 – 60Hz |

Acoustic Data

| | |
|----------------------|----------------------|
| Horn version | directional |
| Sound pressure level | max. 120 dB(A) @ 1 m |
| Sound level | 4 |

Signalling devices



Audible/visual signal. device Horn/XENON light fitting

In flameproof enclosure

YL60/324-PL101-00BW30-ST000-0000 Art. No. 319433

Acoustic Data

| | |
|----------------|---------------------------|
| Volume control | Max. -18 dB(A) adjustment |
|----------------|---------------------------|

Lighting Data

| | |
|------|-----------------------|
| Lamp | 5 J xenon flash tubes |
|------|-----------------------|

| | |
|---|-------|
| Effective luminous intensity (1 Hz, flashing) | 25 cd |
|---|-------|

Ambient Conditions

| | |
|---------------------|-----------------------|
| Ambient temperature | -40 °C ... 70 °C (T4) |
|---------------------|-----------------------|

| | |
|---------------------|------------------|
| Storage temperature | -60 °C ... 70 °C |
|---------------------|------------------|

Mechanical Data

| | |
|-------------------------------------|------|
| IP degree of protection (IEC 60598) | IP66 |
|-------------------------------------|------|

| | |
|----------------------------|------|
| Connection chamber version | Ex e |
|----------------------------|------|

| | |
|--------------------|--|
| Enclosure material | Aluminium, powder-coated, Seawater-resistant |
|--------------------|--|

| | |
|------------------|--------------------------|
| Enclosure colour | red, similar to RAL 3020 |
|------------------|--------------------------|

| | |
|-----------------------|-------------------|
| Silicone-free content | Contains silicone |
|-----------------------|-------------------|

| | |
|------------------|--------|
| Trumpet material | PC/PBT |
|------------------|--------|

| | |
|---------------|--------------------------|
| Material dome | Polycarbonate, prismatic |
|---------------|--------------------------|

| | |
|----------------------------|--------------------------|
| Protective collar material | Polycarbonate (PC cover) |
|----------------------------|--------------------------|

| | |
|---------------------|-----------------|
| Wire guard material | Stainless steel |
|---------------------|-----------------|

| | |
|---------------------------------|-------------------|
| Max. solid connection terminals | 4 mm ² |
|---------------------------------|-------------------|

| | |
|---|---------------------|
| Max. finely stranded connection terminals | 2.5 mm ² |
|---|---------------------|

| | |
|-------|----------|
| Width | 211.8 mm |
|-------|----------|

| | |
|--------|--------|
| Height | 435 mm |
|--------|--------|

| | |
|--------|----------|
| Length | 211.8 mm |
|--------|----------|

| | |
|-------------|------|
| Lens colour | Blue |
|-------------|------|

| | |
|-----------|-----------|
| Fastening | U-bracket |
|-----------|-----------|

| | |
|--------|---------|
| Weight | 8.56 kg |
|--------|---------|

| | |
|--------|----------|
| Weight | 18.88 lb |
|--------|----------|

Mounting / Installation

| | |
|-----------------|---------|
| Connection type | Push in |
|-----------------|---------|

| | |
|------------------------|-----------------|
| Mounting part material | Stainless steel |
|------------------------|-----------------|

Components

| | |
|---------------|-------------------|
| Drilled holes | 2 x M20 + 2 x M25 |
|---------------|-------------------|

| | |
|--------------------------|--|
| Cable glands and entries | 1 x M20 Ø 4 ... 13 mm 1 x M25 Ø 7 ... |
|--------------------------|--|

| | |
|----------------------|------------------|
| Material cable gland | Polyamide, black |
|----------------------|------------------|

| | |
|----------------|-----------------|
| Stopping plugs | 2x M20 + 2x M25 |
|----------------|-----------------|

| | |
|------------------------|------------------|
| Stopping plug material | Polyamide, black |
|------------------------|------------------|

Signalling devices

Audible/visual signal. device Horn/XENON light fitting

In flameproof enclosure

YL60/324-PL101-00BW30-ST000-0000 Art. No. 319433



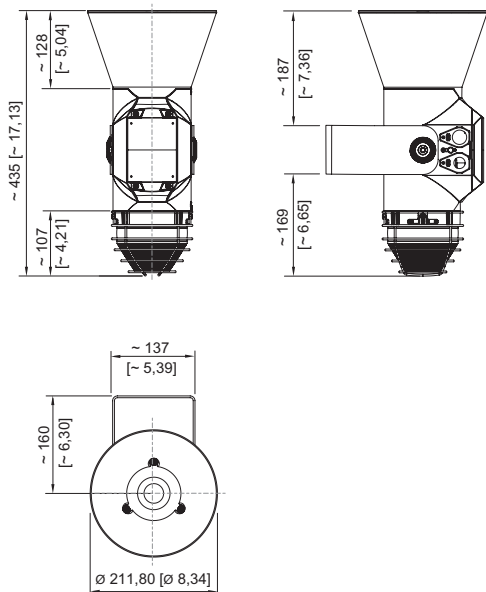

Dimensional Drawings (All Dimensions in mm [inches]) – Subject to Alterations



YL60/3 directional horn

Accessories

Metal cable gland

| | | Art. No. |
|--|--|----------|
|  | Ex d and Ex e cable gland with compound for all types of armoured cables (SWA, wire-braid, tape) (nickel-plated brass) Type 20PX2K, M20 x 1.5 | 109428 |
| | Ex d and Ex e cable glands with RapidEx sealing system for all types of unarmoured cables and wire-braid-armoured cables (nickel-plated brass) Type 20PX2K-REX, M20 x 1.5 | 246649 |
|  | Ex d and Ex e cable glands with compound for all types of unarmoured cables and wire-braid-armoured cables (nickel-plated brass) Type 20PXSS2K, M20 x 1.5 | 109441 |
| | Ex d and Ex e cable glands with RapidEx sealing system for all types of unarmoured cables and wire-braid-armoured cables (nickel-plated brass) Type 20PXSS2K-REX, M20 x 1.5 | 246605 |

Cable gland made of plastic

| | | Art. No. |
|--|--|----------|
|  | 8161/7-M20-1304, Ex e Plastic, M20 x 1.5, cable outer diameter 4 to 13 mm Lot size 50 pieces | 239156 |

Stopping plug

| | | Art. No. |
|--|---|----------|
|  | 8290/3-M20 Plastic, M20 x 1.5 Lot size 1 piece | 143522 |
| | 8290/3-M20 Plastic, M20 x 1.5 Lot size 100 pieces | 285773 |

Signalling devices



Audible/visual signal. device Horn/XENON light fitting

In flameproof enclosure

YL60/324-PL101-00BW30-ST000-0000 Art. No. 319433

Mounting accessories

Art. No.

| | | |
|--|-----------------------------------|--------|
|  | L-bracket, stainless steel 1.4404 | 319271 |
|  | U-bracket, stainless steel 1.4404 | 319280 |

Protective cage

Art. No.

| | | |
|--|---|--------|
|  | Protective cage, stainless steel 1.4404 | 319272 |
|--|---|--------|

Spare Parts

Textured lens

Art. No.

| | | |
|--|------|--------|
|  | blue | 319274 |
|--|------|--------|

Lamp

Art. No.

| | | |
|--|-------------------------|--------|
|  | Xenon tube PCB 5 joules | 319281 |
|--|-------------------------|--------|

Shaped horn

Art. No.

| | | |
|--|-------------------------|--------|
|  | directional, repair kit | 319249 |
|--|-------------------------|--------|

We reserve the right to make alterations to the technical data, dimensions, weights, designs and products available without notice. The illustrations cannot be considered binding.