

Installation equipment

Wall-mounted socket distributor for clean rooms



8150/5-V88-37122-3409 Art. No. 256760



- Mounting flush with the wall with a hygienic design
- Stainless steel enclosure in AISI 316L with a covered sealing system
- A locked switch prevents the connector from being inadvertently pulled out under load
- Versions with single or dual sockets
- Current levels of 16 A and/or 32 A

MY R. STAHL 8150E

The wall-mounted socket distributors for clean rooms from series 8150/5-V88 have been developed for all applications in which particle contamination can affect the quality, purity or service life of a product. For example, in the pharmaceutical industry an excessive particle content restricts the purity of medication, while in the semiconductor industry particles can shorten the service life of components such as chips, LEDs or touchscreens. Other fields include the optical industry (production of lenses and microscopes), the food industry, and the life science and laboratory sectors. With their clear structure and hygienic design, the socket distributors can be installed flush with the wall in the aforementioned areas according to the necessary classification.

Technical Data

Explosion Protection

Scope of validity	European Union (ATEX) IECEX India (PESO)
Application range (zones)	1 2 21 22
IECEX gas certificate	IECEX PTB 09.0049
IECEX gas explosion protection	Ex db eb IIC T6 Gb
IECEX dust certificate	IECEX PTB 09.0049
IECEX dust explosion protection	Ex tb IIIC T80 °C Db
ATEX gas certificate	PTB 09 ATEX 1109
ATEX gas explosion protection	⊕ II 2 G Ex db eb IIC T6 Gb
ATEX dust certificate	PTB 09 ATEX 1109
ATEX dust explosion protection	⊕ II 2 D Ex tb IIIC T80 °C Db
Certificates	ATEX (PTB), IECEX (PTB), India (PESO)

Electrical Data

Looping through possible	Yes
--------------------------	-----

Ambient Conditions

Ambient temperature	-50 °C ... +40 °C
Ambient temperature	-58 °F ... +104 °F

Mechanical Data

Degree of protection (IP) (IEC 60529)	IP66
IP degree of protection (IEC 60079)	IP64

Installation equipment

Wall-mounted socket distributor for clean rooms



8150/5-V88-37122-3409 Art. No. 256760

Mechanical Data

Enclosure material	Stainless steel 1.4404, (AISI 316L), brush finished
Silicone-free	No
Width	238 mm
Width in inches	9.37 in
Height	155 mm
Height, inches	6.1020 in
Length	470 mm
Length, inches	18.51 in
Seal	Silicone, foamed
Enclosure size	176,5x360x91 mm
Weight	7.8 kg
Weight	17.2 lb

Components

Stopping plugs	4 x M25 x 1.5
Stopping plug material	Polyamide, black
Number of sockets 1	1
Socket 1 type	8570/18
Rated operating voltage socket 1	200 ... 250 V
Socket 1 frequency	50/60 Hz
Rated operating current socket 1	16 A
Number of poles on socket 1	4
Socket 1 colour code	Blue
Socket 1 coding	9
Terminal type socket 1	Phoenix UT 6 Phoenix UT 6-PE
Socket 1 connec. cross-section	4 mm ² 6 mm ²
Socket 1 enclosure material	Polyamide, glass fibre reinforced
Switching capacity 1	AC-3: 690 V/25 A AC-3: 500 V/32 A
Switching capacity 1 note	according to IEC/EN 60947-3

Installation equipment

Wall-mounted socket distributor for clean rooms



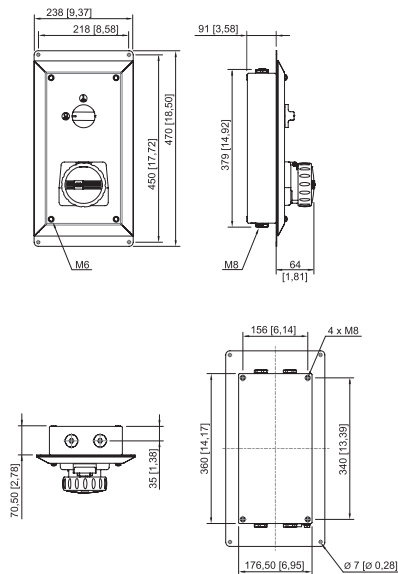

8150/5-V88-37122-3409 Art. No. 256760

Dimensional Drawings (All Dimensions in mm [inches]) – Subject to Alterations

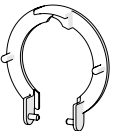

8150/5-V88 with 8570/18, 16 A

Accessories

Dust cover for sockets, Series 8570		Art. No.
	Retrofittable dust protection for 4-pole sockets	255003
Plug		Art. No.
	8570/12-409-S-XX-X-XX-XXX 4-pole plug, 200 to 250 V AC, 50/60 Hz, 16 A	272891

We reserve the right to make alterations to the technical data, dimensions, weights, designs and products available without notice. The illustrations cannot be considered binding.