

Control and signalling devices

Control devices for panel mounting

Ex e

8003/131-012S UL Art. No. 257238



- Flexible configuration thanks to pushbutton, mushroom push-button, mushroom stay-put button, mushroom stay-put button with key lock, key-operated button and key-operated switch
- Easy to install using a single hole
- Codable "latching", "spring return" and "key not removable" functions
- Spring clamp terminals with connection chamber

MY R. STAHL 8003A



R. STAHL Series 8003 switches and control buttons for panel mounting take on various switching functions in latching and spring return positions up to 6 A, which can be subsequently recoded. They are fully certified, explosion-protected equipment with an Ex e connection chamber. With the patented mounting mechanism, panel mounting with drilled holes or openings of 30.5 mm is quick and easy.

Compatible actuators are available for a comprehensive range of applications.

Technical Data

Explosion Protection

Area of application	European Union (ATEX) CE Code IECEX NEC®
Application range (zones)	1, 2, 21, 22
IECEX gas certificate	IECEX PTB 06.0065X
IECEX gas explosion protection	Ex db eb IIC T6 Gb
IECEX dust certificate	IECEX PTB 06.0065X
IECEX dust explosion protection	Ex tb IIIC T80 °C Db
ATEX gas certificate	PTB 02 ATEX 1057 X
ATEX gas explosion protection	⊕ II 2 G Ex db eb IIC T6 Gb
ATEX dust certificate	PTB 02 ATEX 1057 X
ATEX dust explosion protection	⊕ II 2 D Ex tb IIIC T80 °C Db
Certificates	ATEX (PTB), Canada (UL), China (CQST), IECEX (PTB), Korea (KGS), USA (UL)
Declaration of conformity	ATEX (EUK), ATEX (Simple apparatus), China (CCC)
Notes	Product label may vary. Series devices are labelled with ATEX, IECEX, NEC® and CE Code.

Electrical Data

AC rated operational voltage	500 V
Rated operational current	6 A
Rated operational current	6 A
Switching capacity AC-12	500 V / 6 A / max. 3000 VA
Switching capacity AC-15	400 V / 6 A / max. 1250 VA
Switching capacity DC-13	110 V / 1 A / max. 110 W
Switching capacity DC-13 2 contact elements in series	60 V/6 A

Control and signalling devices

Control devices for panel mounting



Ex e

8003/131-012S UL Art. No. 257238

Ambient Conditions

Ambient temperature	-55 °C ... 60 °C
Ambient temperature	-67 °F ... +140 °F
Ambient temperature NEC®	-55 °C ... +60 °C
Ambient temperature NEC®	-67 °F ... +140 °F

Mechanical Data

Degree of protection (IP) (IEC 60529)	Reverse side IP65, front side IP66
Enclosure material	Polyamide
Contact material	Silver-nickel
Silicone-free	No
Number of NOs	2
Connection cross-section	0.75 ... 1.5 mm ²
Connection cross-section AWG	18 AWG ... 12 AWG
Mounting depth	130 mm
Mounting depth in inches	5.12 in
Service life, min.	10 ⁵ operating cycles
Weight	125 g

Mounting / Installation

Tightening torque	3 N · m
Tightening torque lbf in	26.55 lbf in

Components

Actuator	Mushroom stay-put button
Entry 1	8161/7-M16-0902
Entry 1 type	Polyamide cable gland, black

Technical Drawings – Subject to Alterations



Schematic 8003/13.
NO

Dimensional Drawings (All Dimensions in mm [inches]) – Subject to Alterations

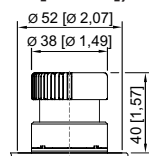
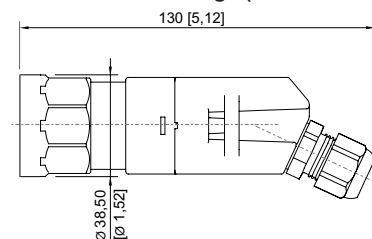

8003/...-010, 8003/...-012 mushroom stay-put button
dia. 38 mm

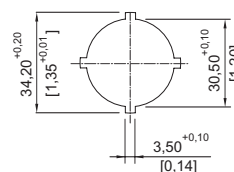

Punch pattern

Control and signalling devices

Control devices for panel mounting



Ex e

8003/131-012S UL Art. No. 257238

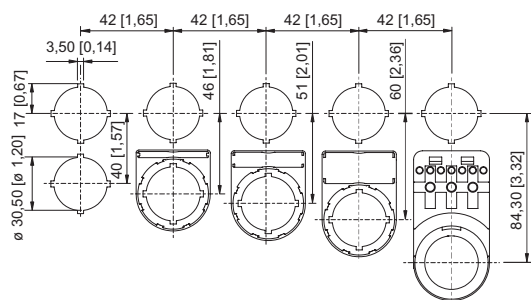

Cut-out with/without additional designation plate

Accessories

Actuators

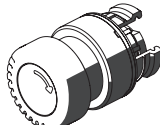

		Art. No.
	Mushroom stay-put button dia. 38 mm, black	155541

Closing part

		Art. No.
	8602C3-733-B for closing unused holes in cover, dia. 30.5 mm, NBR	244306
	8602C3-733-S for closing unused holes in cover, dia. 30.5 mm, silicone	244307

Spare Parts

Label holder

		Art. No.
	Label holder, size 1, without insert disc Labelling: 1-line can be installed in dia. 30.5 mm drilled holes for actuators	155632
	Label holder, size 2, without insert disc Labelling: 1- or 2-line can be installed in dia. 30.5 mm drilled holes for actuators	155687
	Label holder, size 3, without insert disc Labelling: 1-, 2- or 3-line can be installed in dia. 30.5 mm drilled holes for actuators	155844

Protective collar

		Art. No.
	8602A0751 metal for pushbutton/selector switch/mushroom stay-put button with key lock/mushroom stay-put button/mushroom pushbutton dia. 39 BG001, BG003, BG005, BG008, BG009, BG010, BG012	155326

Control and signalling devices

Control devices for panel mounting

Ex e

8003/131-012S UL Art. No. 257238



Designation plates for pushbuttons and selector switches

Art. No.

	Colour: Red Symbol: Arrow	155567
--	------------------------------	--------

Insert discs for label holder

Art. No.

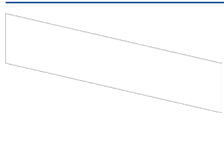
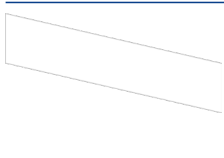
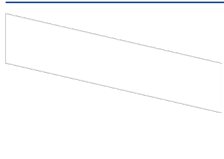
	One-line Plain Material: PVC Colour: White Self-adhesive	238271
	Two-line Plain Material: PVC Colour: White Self-adhesive	238272
	Three-line Plain Material: PVC Colour: White Self-adhesive	238273

We reserve the right to make alterations to the technical data, dimensions, weights, designs and products available without notice. The illustrations cannot be considered binding.