

8602C3-736-B-XXX-E08 Art. No. 318417



- Pushbutton, mushroom pushbutton, mushroom stay-put button with key lock, mushroom stay-put button, twin pushbutton and illuminated pushbutton, rotary actuator, key-operated switch, potentiometer bezel and indicator lamp bezel
- One axial actuator can actuate up to four Series 8082 contact elements
- Key-operated switches and rotary switches codable at any time as "latching/spring return" or "key not removable"

MY R. STAHL 8602A



Thanks to their special technical features, the actuators from the 8602/3 series can withstand the most extreme conditions. In addition to the application option for use in ambient temperatures from -60 °C to +70 °C, the IP degree of protection, IP66, is maintained in accordance with EN 60529. It is also possible to actuate up to four contact elements from the 8082 series with a single axial actuator from the 8602/3 series.

The coding option of the key switches and rotary switches is innovative and one-of-a-kind. Integrated coding allows you to adjust the "latching/spring return" and/or "key not removable" functions at any time without additional accessories. A versatile set of accessories consisting of label holders and locking devices is available.

Technical Data

Explosion Protection

Application range (zones)	1, 2, 21, 22
IECEX gas certificate	IECEX PTB 13.0047U
IECEX gas explosion protection	Ex eb IIC Gb
IECEX dust certificate	IECEX PTB 13.0047 U
IECEX dust explosion protection	Ex tb IIIC Db
ATEX gas explosion protection	Ex II 2 G Ex eb IIC Gb
ATEX dust explosion protection	Ex II 2 D Ex tb IIIC Db
UL gas certificate	E182378 V4 S2
Certificate ULus	E182378 V4 S2
Marking ULus	Class I, Zone 1, AEx eb IIC Gb Zone 21, AEx tb IIIC Db
Certificate cUL	E182378V4S2
Marking cUL	Class I, Zone 1, Ex eb IIC Gb Zone 21, Ex tb IIIC Db
Inmetro gas certificate	UL-BR 14.0380U
Inmetro dust certificate	UL-BR 14.0380U
Certificates	ATEX (PTB), Canada (UL), IECEX (PTB), Korea (KGS), USA (UL)

Ambient Conditions

Ambient temperature	-20 °C ... 60 °C
Ambient temperature	-4 °F ... +140 °F
Storage temperature	-25 °C ... 60 °C
Storage temperature	-13 °F ... +140 °F
Use at the height of	< 2000 m

8602C3-736-B-XXX-E08 Art. No. 318417

Ambient Conditions

Max. operating altitude	2000 m
Degree of pollution	3

Mechanical Data

Degree of protection (IP)	IP66
Note on degree of protection	According to IEC/EN 60529
Enclosure material	Polyamide
Silicone-free	Yes
Assembly	736
Diameter	64 mm
Service life, min.	10 ⁵ actuations
Impact strength (IEC 60079)	7 J
Impact strength (IEC 62262)	min. IK08
Handle colour	Black
Protective collar colour	Black
Mounting	Thread type
Seal	Standard
Packaging unit	1
Decription note	Lockable option (max. 3 times) can be determined using the enclosed closing parts. Lockable handle position: Not defined. In the unmounted assemblies, the standard label is 0/OFF-I/ON and the long coupling part is enclosed. Other labels must be ordered separately.
Weight	71 g
Weight	0.16 lb

Mounting / Installation

Mounting type	Front panel mounting
Tightening torque	3 N · m
Tightening torque lbf in	26.55 lbf in

Technical Drawings – Subject to Alterations

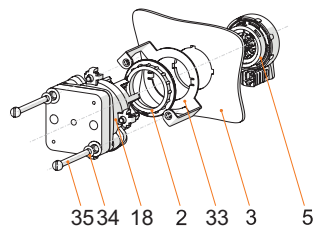

Front installation mounting with Series 8008 control switch

Key

- 2 = jam nut (order no. 205592)
- 3 = installation wall (wall thickness max. 2 mm [0.0787 inch])
- 5 = 8302/3 actuator with seal (4)
- 18 = 8008/2- control switch
- 33 = front installation 8602/3 adaptor for type 8008/2
- 34 = M4 disc
- 35 = M4x screw

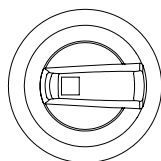

Explanation of position display:
Standard switch, lockable in 0/OFF
Position of handle 90°

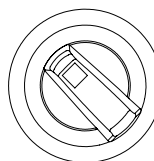

Explanation of position display:
Standard switch, lockable in 0/OFF
Position of handle 45°

8602C3-736-B-XXX-E08 Art. No. 318417

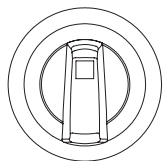

Explanation of position display:
 Safety switch, lockable in I/ON
 Position of handle 0°

Dimensional Drawings (All Dimensions in mm [inches]) – Subject to Alterations

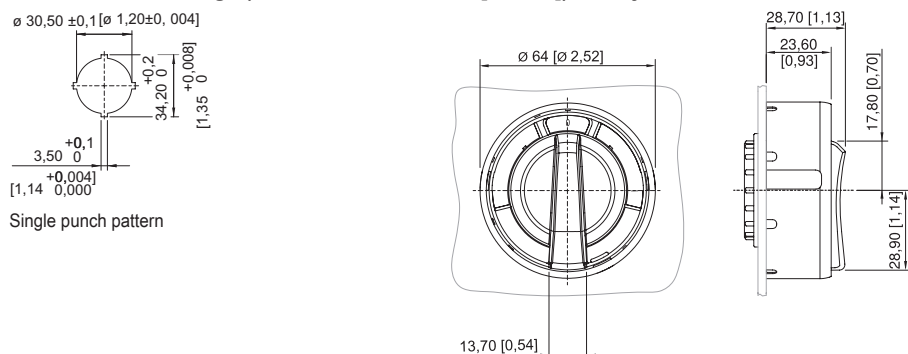

8602/3-736 maxi rotary actuator, black handle, black protective collar
 8602/3-737 maxi rotary actuator, red handle, yellow protective collar
 Actuator with radial actuation

Accessories

Cylinder lock





for closing (bracket Ø 3)

Art. No.

107115

Spare Parts

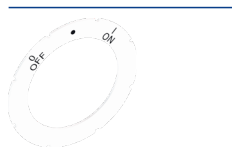
Labels for rotary actuator Maxi BG736, BG737

		Art. No.
	Dia. 58.5 0/OFF I/ON	274882
	Dia. 58.5 0/OFF • I/ON	318459
	Dia. 58.5 0 BETRIEB I	263982

8602C3-736-B-XXX-E08 Art. No. 318417

Labels for rotary actuator Maxi BG736, BG737

		Art. No.
	Dia. 58.5 0 EIN	270806
	Dia. 58.5 0 I	318506
	Dia. 58.5 0 I II	318507
	Dia. 58.5 AUS AUTO EIN	270807
	Dia. 58.5 AUTO 0 BETRIEB I	270808
	Dia. 58.5 HAND 0 AUTO	318460
	Dia. 58.5 I 0 I 0	318501
	Dia. 58.5 I 0 II	318502
	Dia. 58.5 I II	318503
	Dia. 58.5 ••••••	318504

Special key

		Art. No.
	for tightening plastic locking nut	169101

8602C3-736-B-XXX-E08 Art. No. 318417

Adaptor with fastening material for front installation

Art. No.

	8602/3 front installation for control switch of Series 8008/2-0 max. wall thickness 2 mm	297995
	8602/3 front installation for control switch of Series 8008/2-6 max. wall thickness 2 mm	297996
	8602/3 front installation for control switch of Series 8008/2-1 max. wall thickness 2 mm	297997

We reserve the right to make alterations to the technical data, dimensions, weights, designs and products available without notice. The illustrations cannot be considered binding.