

Lighting

Linear luminaire With LED

GRP

6602/1223-0100-152-1111-11-857 Art. No. 325351



- Smart Central Locking System – Allows effortless access for quick maintenance, minimizing downtime and enhancing operational efficiency.
- Advanced Surge Protection up to 2KV – Engineered for resilience, the robust design shields the luminaire from electrical surges, ensuring long-lasting performance.
- Superior Energy Efficiency – Achieves an outstanding 130 lumens per watt, delivering maximum illumination with minimal energy consumption.
- Long-Lasting LED Performance – Designed for durability, the luminaire delivers over 60,000 hours of service life even in +55°C ambient conditions.

MY R. STAHL 6602A

The 6602 linear LED luminaire is built to withstand harsh conditions, making it ideal for industries such as oil & gas, specialty chemicals, and pharmaceuticals and similar hazardous environments. With its high-performance illumination, it is perfect for lighting large surfaces at mounting heights of up to 10 meters, as well as illuminating equipment and objects both indoors and outdoors. For added flexibility, the luminaire can be easily mounted on poles using the pole mounting sleeve accessory, ensuring adaptable installation across various industrial settings.

Technical Data

Explosion Protection	
Ex version	Yes
Application range (zones)	2, 21, 22
IECEX gas certificate	IECEX IBE 24.0030X
IECEX gas explosion protection	Ex nR IIC T6 Gc
IECEX dust certificate	IECEX IBE 24.0030X
IECEX dust explosion protection	Ex tb IIIC T85 °C Db
Certificates	IECEX (IBE), India (PESO)
Electrical Data	
Control gear service life	C10 ≥ 50 h, Ta ≤ 55 °C
LED service life	L70B50 ≥ 60 h
Lighting Data	
Number of lamps	1
Lamp wattage	22 W
Lamp	LED
Light colour	5700 K – cool white
Light distribution	120°x120° with diffusing glass
Luminaire efficacy	125 lm/W
Luminous flux	2837 lm
Colour rendering	≥ 80
Colour temperature	5700 K
Mechanical Data	
Version	Standard
IP degree of protection (IEC 60598)	IP66/IP67
Enclosure material	Polyester resin, Glass fibre reinforced
Enclosure colour	Light grey (RAL 7035)

Lighting

Linear luminaire With LED

GRP

6602/1223-0100-152-1111-11-857 Art. No. 325351



Mechanical Data

Diffuser	With diffuser
Sealing material	Silicone
Silicone-free content	Contains silicone
Translucent cover material	Polycarbonate
Installed terminal strip	PE + N + L1 + L2 + L3
Max. solid connection terminals	6 mm ²
Max. finely stranded connection terminals	4 mm ²
Type of connection cable	Finely stranded Solid
Size	2
Width	184 mm
Height	125 mm
Length	700 mm
Impact strength (IEC 62262)	IK10
Disconnection of the luminaire	No
Weight	3.7 kg
Weight	8.16 lb

Components

Threaded plate	2x plastic
Ballast	Inventronics -OT FIT
Through wiring	With 5 conductors 2.5 mm ²
Drilled holes	4 x M25
Cable glands and entries	3xM25 Ø 7 ... 17 mm (1x plug)
Material cable gland	Polyamide, black
Stopping plugs	1 x M25 x 1.5
Stopping plug material	Polyamide, black
Accessories	Provided

Light Distribution Curves

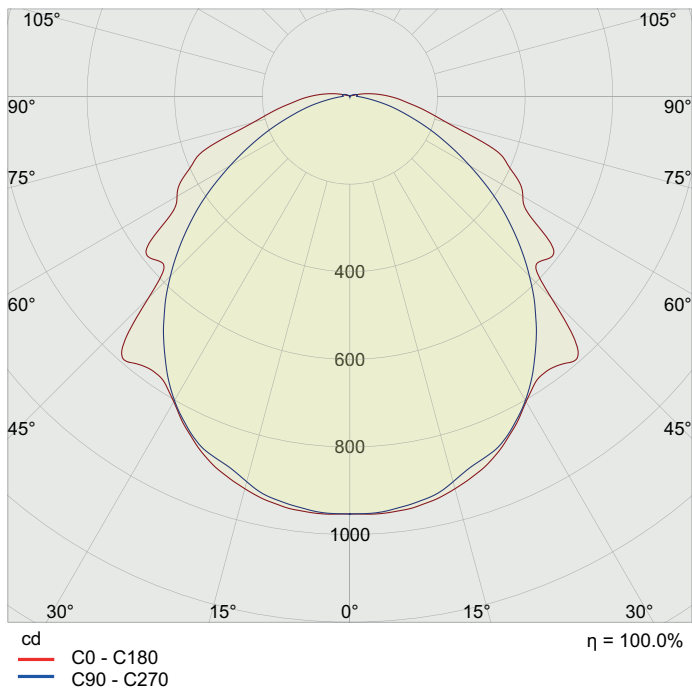

Size 2

Dimensional Drawings (All Dimensions in mm [inches]) – Subject to Alterations

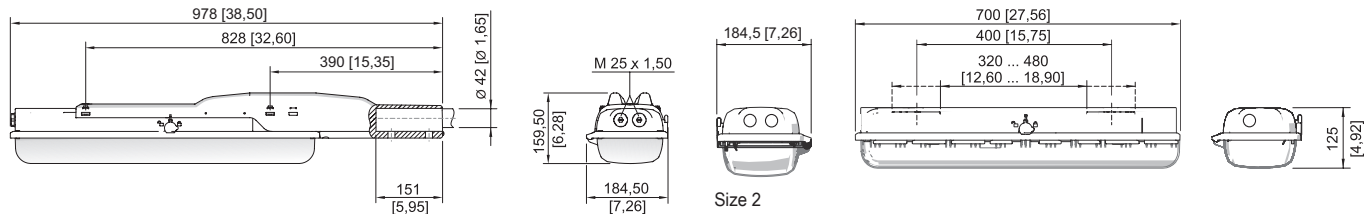

Size 2

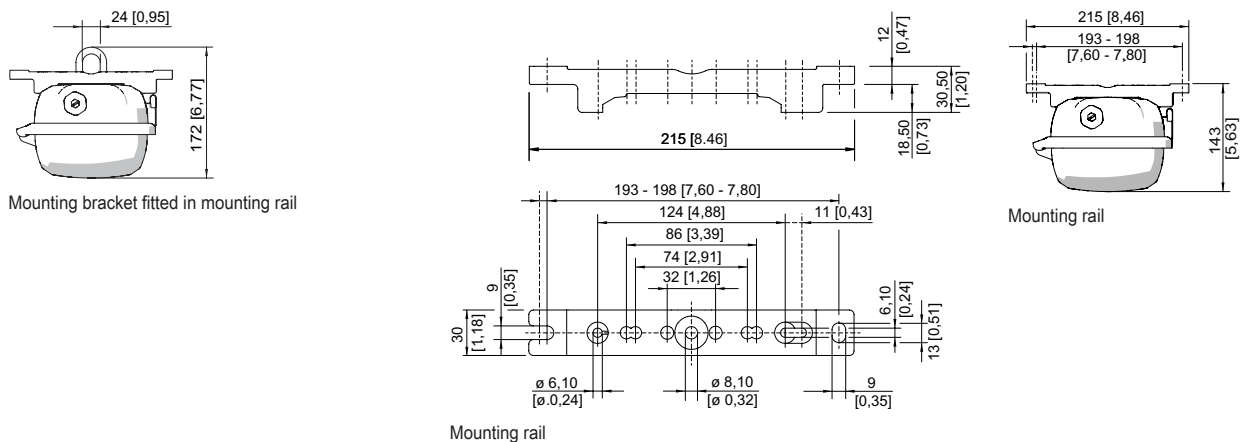

Lighting

Linear luminaire With LED

GRP

6602/1223-0100-152-1111-11-857 Art. No. 325351

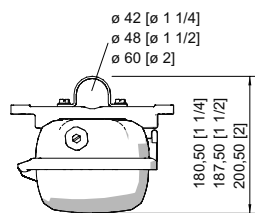

Pipe clamp fitted in mounting rail

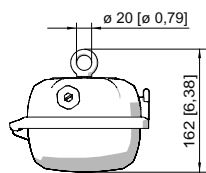

Ring bolt fitted in insert nut of the luminaire

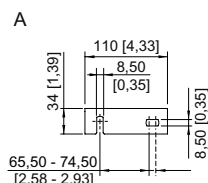
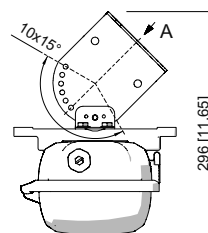

Wall mounting bracket fitted in mounting rail

Accessories

Box spanner

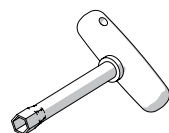

M8 / A/F 13;
For actuating the central lock

Art. No.

222430

Breather

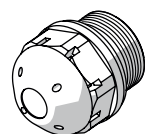

Thread: M25 x 1.5 (20 pieces); without jam nut

Art. No.

285780

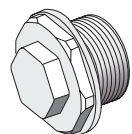

Thread: M25 x 1.5 (1 piece); for installation in light fittings; made from stainless steel; without jam nut

296608

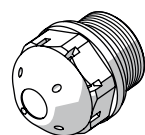

M25 x 1.5 in order to avoid condensate formation

115738

Ceiling and wall mounting bracket

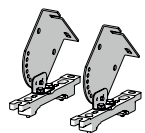

mounted on a mounting rail for a variable mounting distance; Material: stainless steel; Lamp can be swiveled in steps of 15°; 1 pair

Art. No.

222827

Mounting bracket

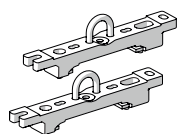

mounting clamp mounted on a mounting rail for a variable mounting distance; 1 pair

Art. No.

222456

Lighting

Linear luminaire With LED

GRP

6602/1223-0100-152-1111-11-857 Art. No. 325351

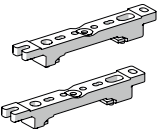

Mounting rail

		Art. No.
	for a variable mounting distance; 1 pair	222826

Pipe clamp

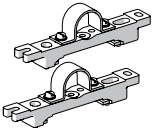
		Art. No.
	R 1 1/2"; with mounting rail for a variable mounting distance; material: stainless steel; 1 pair	222459
	R 1 1/4"; with mounting rail for a variable mounting distance; Material: stainless steel; 1 pair	222458
	R 2"; with mounting rail for a variable mounting distance; Material: stainless steel; 1 pair	222460

Pole mounting

		Art. No.
	Pole mounting acces. 1.4301 \varnothing 38mm-1 pair	324916
	Pole mounting acces. 1.4301 \varnothing 42mm-1 pair	324914
	Pole mounting acces. 1.4301 \varnothing 50mm-1 pair	324915
	Pole mounting acces. 1.4301 \varnothing 60mm-1 pair	324912
	Pole mounting acces. 1.4404 \varnothing 50mm-1 pair	324917
	Pole mounting acces. 1.4404 \varnothing 60mm-1 pair	324913

Pole mounting sleeve

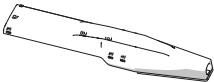
		Art. No.
	for the subsequent mounting on lights size 2 and size 4, completely with assembly parts (for pipe diameter 42 mm)	227512

Ring bolt

		Art. No.
	M8, direct mounting in insert nuts; 1 pair	115736

Wall mounting

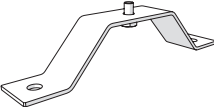
		Art. No.
	Wall/ceiling mtg.bkt. 1.4301w-1pair	324918

Spare Parts

Cover

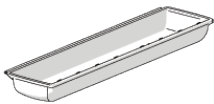
		Art. No.
	for luminaire size 2	222427

We reserve the right to make alterations to the technical data, dimensions, weights, designs and products available without notice. The illustrations cannot be considered binding.