

Signalling devices



Audible signalling device Sounder

In flameproof enclosure

YA60/336-PS001-000010-ST000-0000 Art. No. 327770



- The latest generation of audible and visual alarm devices
- Ex d/Ex e connection chambers
- Audible solutions with directional or omnidirectional horn with up to 120 dB(A) at 1 m, 4 tone channels and 64 preconfigured tones
- Four output levels can be configured
- Brackets and fixings made from stainless steel
- Fastening bracket included

MY R. STAHL YA60C



The **YA60/3 product series** provides audible alarm signals which can be used to alert, warn or draw attention to equipment malfunction/start-up or any number of safety-related issues in hazardous areas. The preconfigured signal tones provide a wide range of internationally standardised signal patterns, whereby four channels are available for each, enabling flexible use.

Technical Data

Explosion Protection

Area of application	European Union (ATEX) IECEX
Application range (zones)	1, 2, 21, 22
IECEX gas certificate	IECEX EPS 22.0046 X
IECEX gas explosion protection	Ex db IIC T6 / T4 Gb
IECEX dust certificate	IECEX EPS 22.0046 X
IECEX dust explosion protection	Ex tb IIIC T80 °C / T100 °C Db
ATEX gas certificate	EPS 22 ATEX 1 224 X
ATEX gas explosion protection	⊕ II 2 G Ex db IIC T6 / T4 Gb
ATEX dust certificate	EPS 22 ATEX 1 224 X
ATEX dust explosion protection	⊕ II 2 D Ex tb IIIC T80 °C / T100 °C Db
Certificates	ATEX (BVIS), IECEX (BVIS)
Declaration of conformity	ATEX (EUK)

Electrical Data

AC rated operational voltage	110 ... 240 V
Rated operational voltage DC	133 ... 272 V
Line monitoring	Yes

Acoustic Data

Horn version	omnidirectional
Sound pressure level	max. 114 dB(A) @ 1 m
Sound level	4
Volume control	18 dB (A) adjustment

Ambient Conditions

Ambient temperature	-40 °C ... 40 °C (T6) -40 °C ... 70 °C (T4)
Storage temperature	-60 °C ... 70 °C
Humidity	95 %

Signalling devices



Audible signalling device Sounder

In flameproof enclosure

YA60/336-PS001-000010-ST000-0000 Art. No. 327770

Mechanical Data

IP degree of protection (IEC 60598)	IP66
Connection chamber version	Ex d
Enclosure material	Aluminium, powder-coated, Seawater-resistant
Enclosure colour	red, similar to RAL 3020
Silicone-free content	Contains silicone
Trumpet material	PC/PBT
Max. solid connection terminals	4 mm ²
Max. finely stranded connection terminals	2.5 mm ²
Width	176 mm
Height	319 mm
Length	128 mm
Mounting	L-bracket
Weight	6.67 kg

Mounting / Installation

Connection type	Push in
Mounting part material	Stainless steel

Components

Drilled holes	2x M20 + 2x 1/2"
Stopping plugs	2x M20 + 2x 1/2"
Stopping plug material	Nickel-plated brass

Dimensional Drawings (All Dimensions in mm [inches]) – Subject to Alterations

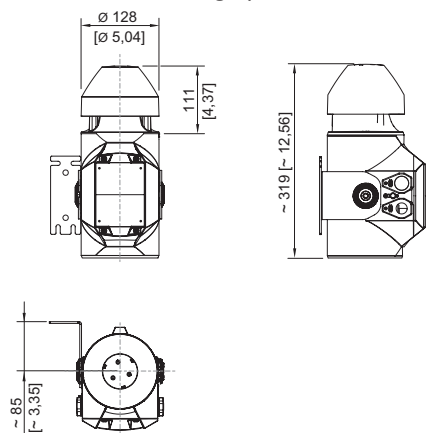

YA60/3 omnidirectional horn

Accessories

Metal cable gland

	Art. No.
 Ex d and Ex e cable gland with compound for all types of armoured cables (SWA, wire-braid, tape) (nickel-plated brass) Type 20PX2K, M20 x 1.5	109428
Ex d and Ex e cable glands with RapidEx sealing system for all types of unarmoured cables and wire-braid-armoured cables (nickel-plated brass) Type 20PX2K-REX, M20 x 1.5	246649

Signalling devices

Audible signalling device Sounder

In flameproof enclosure

YA60/336-PS001-000010-ST000-0000 Art. No. 327770



STAHL

Metal cable gland		Art. No.
	Ex d and Ex e cable glands with compound for all types of unarmoured cables and wire-braid-armoured cables (nickel-plated brass) Type 20PXSS2K, M20 x 1.5	109441
	Ex d and Ex e cable glands with RapidEx sealing system for all types of unarmoured cables and wire-braid-armoured cables (nickel-plated brass) Type 20PXSS2K-REX, M20 x 1.5	246605

Plastic cable gland		Art. No.
	8161/7-M20-1304, Ex e Polyamide, M20 x 1,5 mm, 4 – 13 mm Lot size 50 pieces	239156

Stopping plug		Art. No.
	8290/3-M20 Plastic, M20 x 1.5 Lot size 1 piece	143522
	8290/3-M20 Plastic, M20 x 1.5 Lot size 100 pieces	285773

Spare Parts

Mounting accessories		Art. No.
	L-bracket, stainless steel 1.4404	319271
	U-bracket, stainless steel 1.4404	319280

Shaped horn		Art. No.
	omnidirectional, repair kit	319250

We reserve the right to make alterations to the technical data, dimensions, weights, designs and products available without notice. The illustrations cannot be considered binding.