

Signalling devices

Visual signalling device LED light fitting

In flameproof enclosure

FL60/336-D0801-00BW10-ST000-0000 Art. No. 330631



- The latest generation of audible and visual alarm devices
- Ex d/Ex e connection chambers
- Visual solutions with 5 J XENON and high-power LEDs with various light modes and 4 light channels
- Four output levels can be configured
- Brackets, fixings and protective grid made from stainless steel
- Fastening bracket and protective cage included

MY R. STAHL FL60D



The **FL60/3** product series provides visual alarm signals which can be used to alert, warn or draw attention to equipment malfunction/start-up or any number of safety-related issues in hazardous areas. The preconfigured light patterns (LED) provide a wide range of internationally standardised signal patterns, whereby four channels are available for each, enabling flexible use.

Technical Data

Explosion Protection

Area of application	European Union (ATEX) IECEX
Application range (zones)	1, 2, 21, 22
IECEX gas certificate	IECEX EPS 22.0046 X
IECEX gas explosion protection	Ex db IIC T6 / T4 Gb
IECEX dust certificate	IECEX EPS 22.0046 X
IECEX dust explosion protection	Ex tb IIIC T80 °C / T100 °C Db
ATEX gas certificate	EPS 22 ATEX 1 224 X
ATEX gas explosion protection	⊕ II 2 G Ex db IIC T6 / T4 Gb
ATEX dust certificate	EPS 22 ATEX 1 224 X
ATEX dust explosion protection	⊕ II 2 D Ex tb IIIC T80 °C / T100 °C Db
Certificates	ATEX (BVIS), IECEX (BVIS)
Declaration of conformity	ATEX (EUK)

Electrical Data

Rated operational voltage DC	12 ... 27.2 V
Line monitoring	Yes

Lighting Data

Lamp	LED dome light fitting
Effective light beam (continuous light, 100%)	162 lm
Effective luminous intensity (1 Hz, flashing)	95 cd

Ambient Conditions

Ambient temperature	-40 °C ... 40 °C (T6) -40 °C ... 70 °C (T4)
Storage temperature	-60 °C ... 70 °C
Humidity	95 %

Signalling devices



Visual signalling device LED light fitting

In flameproof enclosure

FL60/336-D0801-00BW10-ST000-0000 Art. No. 330631

Mechanical Data

IP degree of protection (IEC 60598)	IP66/67
Connection chamber version	Ex d
Enclosure material	Aluminium, powder-coated, Seawater-resistant
Enclosure colour	red, similar to RAL 3020
Silicone-free content	Contains silicone
Material dome	Polycarbonate, prismatic
Material glass dome	Polycarbonate, prismatic
Protective collar material	Polycarbonate (PC cover)
Wire guard material	Stainless steel
Max. solid connection terminals	4 mm ²
Max. finely stranded connection terminals	2.5 mm ²
Clamping range	0.5 ... 4 mm
Width	176 mm
Height	317 mm
Length	128 mm
Lens colour	Blue
Mounting	L-bracket
Weight	5.4 kg

Mounting / Installation

Connection type	Push in
Mounting part material	Stainless steel

Components

Drilled holes	2x M20 + 2x 1/2"
Stopping plugs	2x M20 + 2x 1/2"
Stopping plug material	Nickel-plated brass

Dimensional Drawings (All Dimensions in mm [inches]) – Subject to Alterations

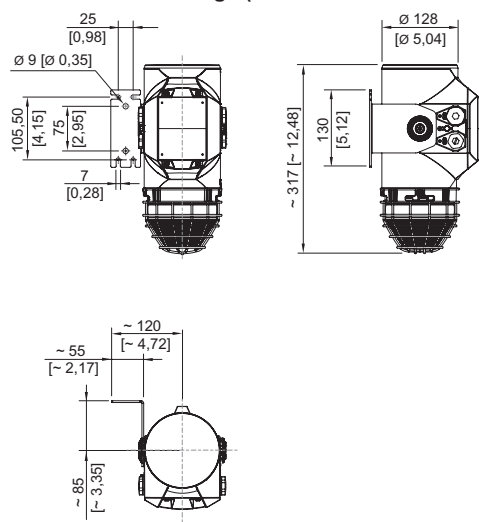

Signalling devices



Visual signalling device LED light fitting

In flameproof enclosure

FL60/336-D0801-00BW10-ST000-0000 Art. No. 330631

STAHL



Accessories

Metal cable gland		Art. No.
	Ex d and Ex e cable gland with compound for all types of armoured cables (SWA, wire-braid, tape) (nickel-plated brass) Type 20PX2K, M20 x 1.5	109428
	Ex d and Ex e cable glands with RapidEx sealing system for all types of unarmoured cables and wire-braid-armoured cables (nickel-plated brass) Type 20PX2K-REX, M20 x 1.5	246649
	Ex d and Ex e cable glands with compound for all types of unarmoured cables and wire-braid-armoured cables (nickel-plated brass) Type 20PXSS2K, M20 x 1.5	109441
	Ex d and Ex e cable glands with RapidEx sealing system for all types of unarmoured cables and wire-braid-armoured cables (nickel-plated brass) Type 20PXSS2K-REX, M20 x 1.5	246605

Plastic cable gland		Art. No.
	8161/7-M20-1304, Ex e Polyamide, M20 x 1,5 mm, 4 – 13 mm Lot size 50 pieces	239156

Stopping plug		Art. No.
	8290/3-M20 Plastic, M20 x 1.5 Lot size 1 piece	143522
	8290/3-M20 Plastic, M20 x 1.5 Lot size 100 pieces	285773

Spare Parts

Mounting accessories		Art. No.
	L-bracket, stainless steel 1.4404	319271
	U-bracket, stainless steel 1.4404	319280

Protective cage		Art. No.
	Protective cage, stainless steel 1.4404	319272

Signalling devices



Visual signalling device LED light fitting

In flameproof enclosure

FL60/336-D0801-00BW10-ST000-0000 Art. No. 330631

Textured lens

Art. No.



blue

319274

We reserve the right to make alterations to the technical data, dimensions, weights, designs and products available without notice. The illustrations cannot be considered binding.