



- Supplies with neoprene gasket, two pressure rings
- For reliable seal, use pressure ring according to cable diameter

MY R. STAHL T71xxA



TRANBERG cable glands have been manufactured at our factory in Stavanger for several decades. Our heavy duty series of cable glands are preferred for many projects. We are the Norwegian market leader for selected cable glands.

Technical Data

Explosion Protection

Ex version	No
------------	----

Mechanical Data

Strain relief	No
Silicone-free	No
Halogen-free	No
Number of cables	1
Armouring type	Unarmoured cable types
Dimension D	8 mm
Thread size	BSPP1-1/4
Lot size	1
Weight	300 g

Dimensional Drawings (All Dimensions in mm [inches]) – Subject to Alterations

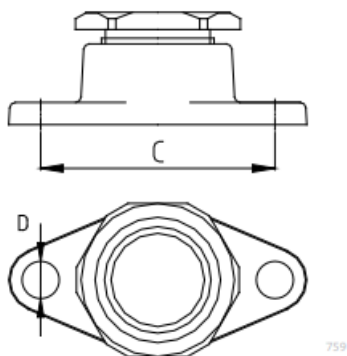

We reserve the right to make alterations to the technical data, dimensions, weights, designs and products available without notice. The illustrations cannot be considered binding.