

TEF4902100 Art. No. 332488



- Backlit text and graphics with dimming control
- Audible and visual alarms
- Main and spare lanterns in same buttons
- Function keys which automatically turns on and off outputs
- Custom made graphics and text

MY R. STAHL T4900B



The operator panels for TEF 4900 Commander are very flexible in sizes and configurations. The panels are custom built and allow for use of text in several languages as well as graphics, such as small frames, etc. With a dimmable backlight these are easy to read in daylight as well as at night. Several panels may be connected to the same network, more typical with non-critical applications. Main and spare lanterns are handled in the same button, which simplifies and enhances safety. Automatic change over to spare lanterns with full alert tracing. Depending on how long the button is pressed, either the main or the backup navigation light is switched on. Special function buttons may be set up to automatically turn on and off lanterns with one single button, such as sailing lanterns on and anchor lanterns off. Alerts are provided with flashing LED's as well as a buzzer for audible alarms.

Applications:

Complete control and monitoring of several types of critical lights on vessels:

- Navigation lights
- Signal lights
- Suez lights
- ROV lights
- Towing lights
- Etc.

Technical Data

Electrical Data	
DC supply voltage	24 V
Power consumption	7.2 W
Number of RS-485 interfaces	2
Auxiliary Power	
Auxiliary pwr nom. voltage DC	24 V
Diagnostics	
Communication	RS-485
Display	
Backlight	Dimmable LED
Mechanical Data	
Degree of protection (IP)	IP22
Enclosure material	Aluminium
Number of buttons	28
Size	2

TEF4902100 Art. No. 332488

Mechanical Data

Mounting cut-out width	220 mm
Mounting cut-out height	205 mm
Weight	-

Technical Drawings – Subject to Alterations

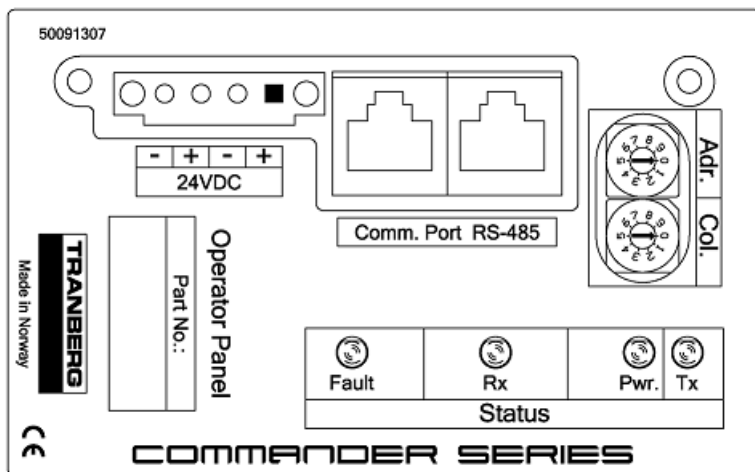

Dimensional Drawings (All Dimensions in mm [inches]) – Subject to Alterations

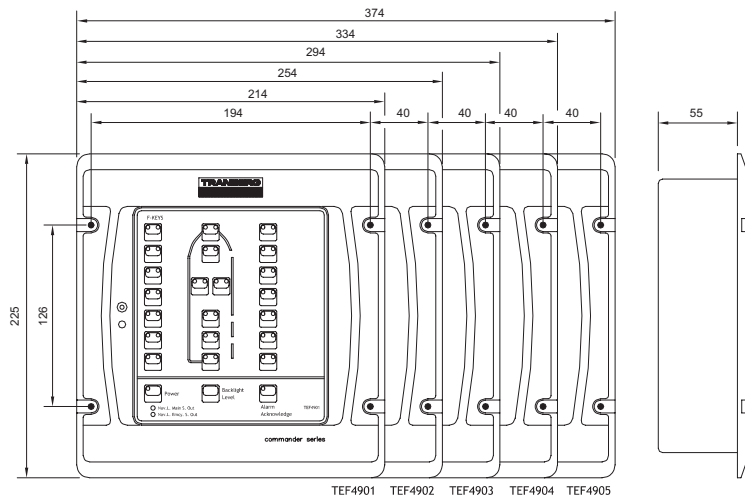

Spare Parts

Operator Panel



TEF4902000 Operator Panel Size 2
Old Art. No.: 4902000

Art. No.

170554

We reserve the right to make alterations to the technical data, dimensions, weights, designs and products available without notice. The illustrations cannot be considered binding.