

Lighting

Emergency luminaire With LED

GRP

6609/1123-0101-162-2220-22-85711 Art. No. 342172



- Smart Central Locking System – Allows effortless access for quick maintenance, minimizing downtime and enhancing operational efficiency.
- Wide Voltage of 100 to 277 V AC – Makes the light fixtures suitable for different applications & environment.
- Advanced Surge Protection up to 6KV – Engineered for resilience, the robust design shields the luminaire from electrical surges, ensuring long-lasting performance.
- Emergency Light Output - Ensures essential visibility during evacuation or system restoration.
 - i. 2 ft model: Up to 65% brightness for 1.5h or 35% for 3h.
 - ii. 4 ft model: Up to 35% brightness for 1.5h or 20% for 3h.
- Long- Lasting LED Performance – Designed for durability, the luminaire delivers over 1,00,000 hours (L70B50) of service life even in +55°C ambient conditions.

MY R. STAHL 6609A

The emergency luminaire with Series 6609/1 LED with integrated battery can be installed in stand-by switching, continuous mode or in switchable stand-by switching. A monthly functional test and annual rated operating time test are performed automatically. The results are indicated by an LED.

Technical Data

Explosion Protection	
Ex version	Yes
Application range (zones)	2, 21, 22
IECEX gas certificate	IECEX EPS 25.0021X
IECEX gas explosion protection	Ex db ec ib mb IIC T4
IECEX dust certificate	IECEX EPS 25.0021X
IECEX dust explosion protection	Ex tc IIIC T80 °C Dc
Certificates and approvals	IECEX
Certificates	IECEX (BVIS), India (PESO)
Electrical Data	
Battery version	NiCd battery, gas-tight
Battery operating voltage	7.2 V
Battery capacity	5 Ah
Self-test function	With (standard)
Control gear service life	C10 ≥ 50 h, Ta ≤ 55 °C
LED service life	L70B50 ≥ 60 h
Lighting Data	
Number of lamps	1
Lamp wattage	26 W
Lamp	LED
Light colour	5700 K – cool white
Light distribution	120°x120° with diffusing glass
Luminaire efficacy	109 lm/W
Luminous flux	2837 lm
Operating time	1.5h emergency lighting operation
Emergency light output	65% – 1.5 h

Lighting

Emergency luminaire With LED

GRP

6609/1123-0101-162-2220-22-85711 Art. No. 342172



Lighting Data

Colour rendering	≥ 80
Colour temperature	5700 K

Mechanical Data

Version	Standard
IP degree of protection (IEC 60598)	IP66/IP67
Enclosure material	Polyester resin, Glass fibre reinforced
Enclosure colour	Light grey (RAL 7035)
Diffuser	With diffuser
Sealing material	Silicone
Silicone-free content	Contains silicone
Translucent cover material	Polycarbonate
Installed terminal strip	PE + N + L1 + L2 + L3 + L´
Max. solid connection terminals	6 mm ²
Max. finely stranded connection terminals	4 mm ²
Type of connection cable	Finely stranded Solid
Size	2
Width	184 mm
Height	125 mm
Length	70 cm
Impact strength (IEC 62262)	IK10
Disconnection of the luminaire	Only battery
Weight	6.3 kg
Weight	13.89 lb

Components

Threaded plate	2x stainless steel
Ballast	6049/111-110-10 + 6246/111-1
Through wiring	With 6 conductors 2.5 mm ²
Drilled holes	3 x M20
Cable glands and entries	can be ordered as an accessory
Stopping plugs	Can be ordered as accessories
Accessories	without

Dimensional Drawings (All Dimensions in mm [inches]) – Subject to Alterations

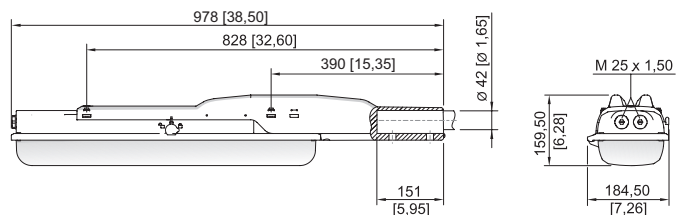

Size 2

Lighting

Emergency luminaire With LED

GRP

6609/1123-0101-162-2220-22-85711 Art. No. 342172

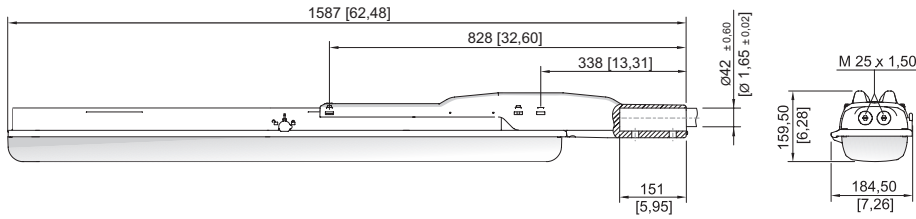

Size 4

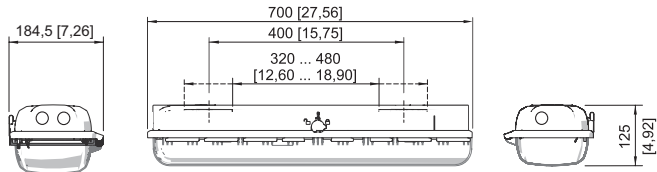

Size 2

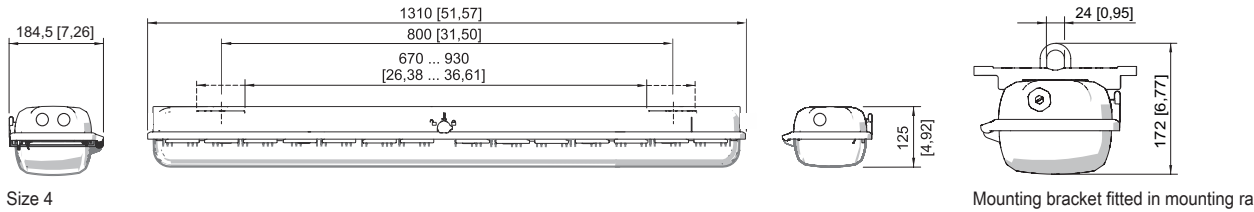

Size 4

Mounting bracket fitted in mounting rail

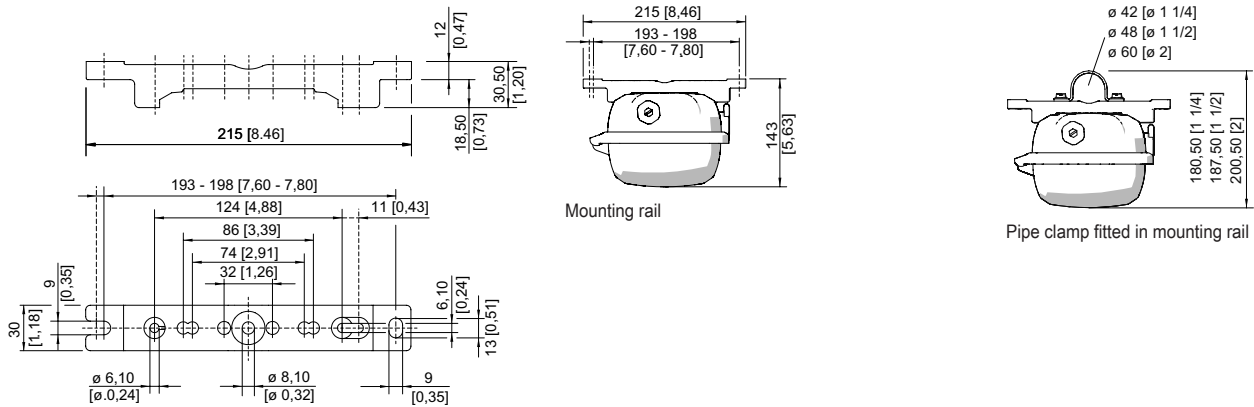

Mounting rail

Mounting rail

Pipe clamp fitted in mounting rail

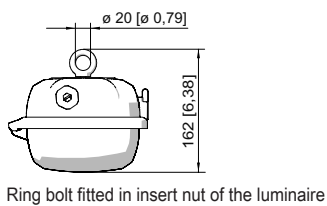

Ring bolt fitted in insert nut of the luminaire

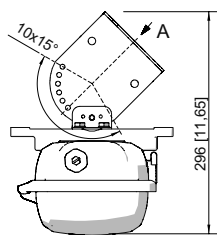

A

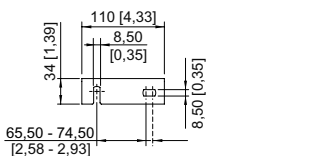

Wall mounting bracket fitted in mounting rail

Lighting

Emergency luminaire With LED

GRP

6609/1123-0101-162-2220-22-85711 Art. No. 342172



Accessories

Box spanner

Art. No.

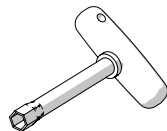

M8 / A/F 13;
For actuating the central lock

222430

Breather

Art. No.

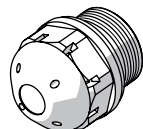

Thread: M25 x 1.5 (20 pieces); without jam nut

285780

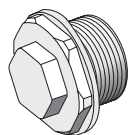

Thread: M25 x 1.5 (1 piece); for installation in light fittings; made from stainless steel; without jam nut

296608

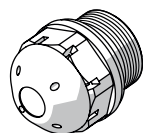

M25 x 1.5 in order to avoid condensate formation

115738

Ceiling and wall mounting bracket

Art. No.

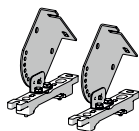

mounted on a mounting rail for a variable mounting distance; Material: stainless steel; Lamp can be swiveled in steps of 15°; 1 pair

222827

Mounting bracket

Art. No.

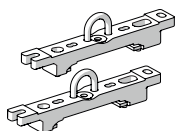

mounting clamp mounted on a mounting rail for a variable mounting distance; 1 pair

222456

Mounting rail

Art. No.

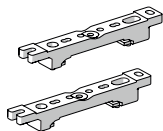

for a variable mounting distance; 1 pair

222826

Pipe clamp

Art. No.

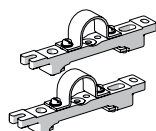

R 1 1/2"; with mounting rail for a variable mounting distance; material: stainless steel; 1 pair

222459

R 1 1/4"; with mounting rail for a variable mounting distance; Material: stainless steel; 1 pair

222458

R 2"; with mounting rail for a variable mounting distance; Material: stainless steel; 1 pair

222460

Lighting

Emergency luminaire With LED

GRP

6609/1123-0101-162-2220-22-85711 Art. No. 342172

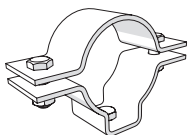

Pole mounting

		Art. No.
	Pole mounting acces. 1.4301 ø38mm-1 pair	324916
	Pole mounting acces. 1.4301 ø42mm-1 pair	324914
	Pole mounting acces. 1.4301 ø50mm-1 pair	324915
	Pole mounting acces. 1.4301 ø60mm-1 pair	324912
	Pole mounting acces. 1.4404 ø50mm-1 pair	324917
	Pole mounting acces. 1.4404 ø60mm-1 pair	324913

Pole mounting sleeve

		Art. No.
	for the subsequent mounting on lights size 2 and size 4, completely with assembly parts (for pipe diameter 42 mm)	227512

Ring bolt

		Art. No.
	M8, direct mounting in insert nuts; 1 pair	115736

Wall mounting

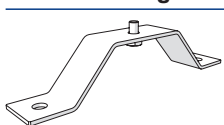
		Art. No.
	Wall/ceiling mtg.bkt. 1.4301w-1pair	324918

Spare Parts

Cover

		Art. No.
	for luminaire size 4	222428
	for luminaire size 2	222427

We reserve the right to make alterations to the technical data, dimensions, weights, designs and products available without notice. The illustrations cannot be considered binding.