

6036/1212-053-0121-17 Art. No. 263762



- Degree of protection IP66 and IP68
- Type of protection Ex d
- Vibration-resistant, lightweight, robust (impact strength rating of IK10) and maintenance-free
- Many light fittings can be connected to single miniature circuit breaker due to incredibly low start-up current

MY R. STAHL 6036B



The 6036 series compact LED tubular light fitting is ideal for general lighting applications and for use as machine lighting, even in relatively inaccessible places with very little space. This light boasts a long service life of up to 100,000 hours thanks to its use of energy-efficient LED technology, coupled with electronics that have been developed in-house by R. STAHL. Due to its robust construction, it can withstand extreme temperatures of between -55 °C and +60 °C.

### Technical Data

#### Explosion Protection

|                                 |   |
|---------------------------------|---|
| Application range (zones)       | 1<br>2<br>21<br>22                      |
| IECEX gas certificate           | IECEX EPS 13.0027                       |
| IECEX gas explosion protection  | Ex db op is IIC T4 Gb                   |
| IECEX dust certificate          | IECEX EPS 13.0027                       |
| IECEX dust explosion protection | Ex tb IIIC T100 °C Db                   |
| ATEX gas certificate            | EPS 13 ATEX 1 597                       |
| ATEX gas explosion protection   | Ex II 2 G Ex db op is IIC T4 Gb         |
| ATEX dust certificate           | EPS 13 ATEX 1 597                       |
| ATEX dust explosion protection  | Ex II 2 D Ex tb IIIC T100 °C Db         |
| Certificates and approvals      | ATEX<br>IECEX<br>ship approval (DNV GL) |
| Certificates                    | ATEX (BVIS), IECEX (BVIS)               |

#### Electrical Data

|                              |             |
|------------------------------|-------------|
| Rated operational voltage AC | 24 – 48 V   |
| Rated operational voltage DC | 24 ... 48 V |
| Frequency range              | 50 – 60 Hz  |

#### Lighting Data

|                    |                |
|--------------------|----------------|
| Number of lamps    | 1              |
| Lamp wattage       | 16 W           |
| Lamp               | Single-row LED |
| Light colour       | Blue           |
| Light distribution | with diffuser  |
| Luminaire efficacy | 27 lm/W        |

6036/1212-053-0121-17 Art. No. 263762

### Lighting Data

|               |                                       |
|---------------|---------------------------------------|
| Luminous flux | 338 lm                                |
| Note          | Values apply to $T_a = +25\text{ °C}$ |

### Ambient Conditions

|                     |                   |
|---------------------|-------------------|
| Ambient temperature | -40 °C ... +70 °C |
| Storage temperature | -40 °C ... +70 °C |

### Mechanical Data

|                                     |                                |
|-------------------------------------|--------------------------------|
| Version                             | Size 1                         |
| Degree of protection (IP)           | IP66 / IP67                    |
| IP degree of protection (IEC 60598) | IP66 / IP68 (10 m / 60 min)    |
| Class                               | II (double insulated)          |
| Enclosure material                  | Polycarbonate                  |
| Silicone-free content               | Silicone-free                  |
| Pipe material                       | Polycarbonate                  |
| Type of connection cable            | H07RN8-F 2x1.5 mm <sup>2</sup> |
| Cable length                        | 2.5 m                          |
| Size                                | 1                              |
| Width                               | 54 mm                          |
| Height                              | 54 mm                          |
| Length                              | 444 mm                         |
| Diameter                            | 54 mm                          |
| Impact strength (IEC 62262)         | IK10                           |
| Weight                              | 1 kg                           |
| Weight                              | 2.2 lb                         |

### Components

|            |          |
|------------|----------|
| Ballast    | LED, CSS |
| Wire guard | No       |

### Technical Drawings – Subject to Alterations

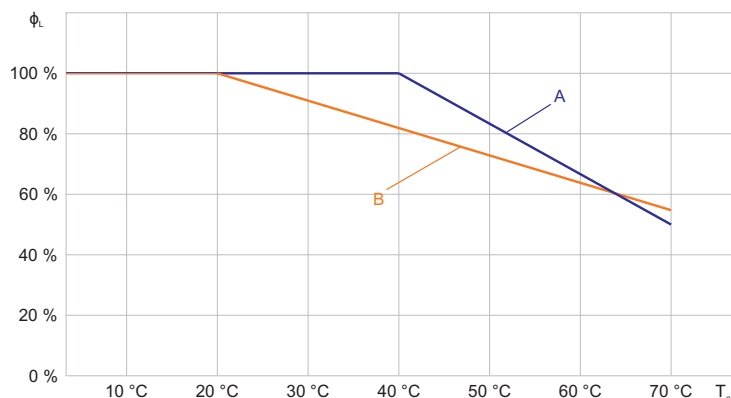

Luminous flux decline relative to ambient temperature

A: Size 1 (110 to 240 V)

B: Size 1 (24 to 48 V)

6036/1212-053-0121-17 Art. No. 263762



Luminous flux decline relative to ambient temperature  
 A: Size 2  
 B: Size 3  
 C: Size 4

### Light Distribution Curves

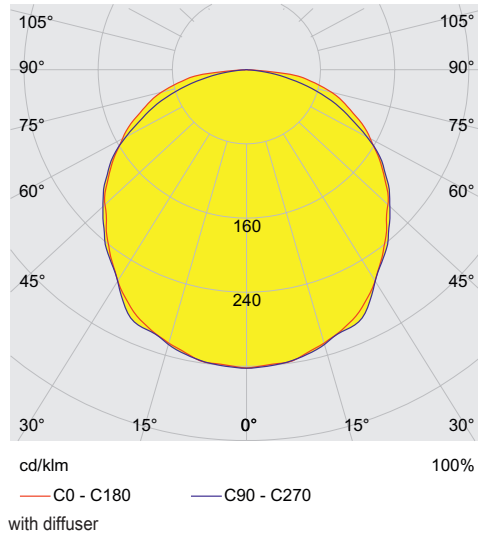

### Dimensional Drawings (All Dimensions in mm [inches]) – Subject to Alterations

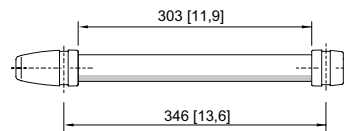
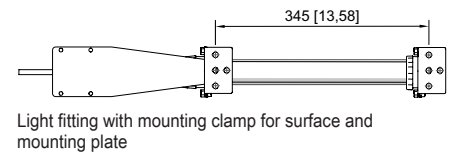
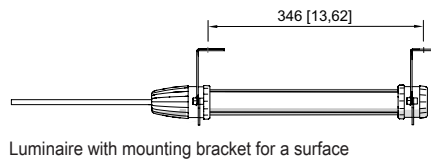
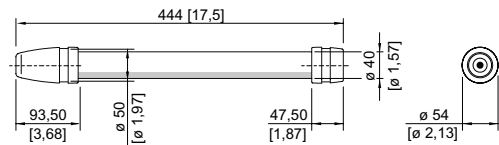

Design size 1

6036/1212-053-0121-17 Art. No. 263762

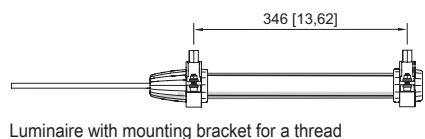

Luminaire with mounting bracket for a thread

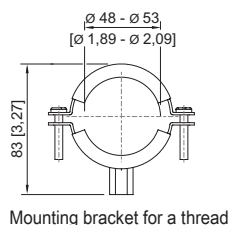
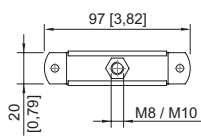

Mounting bracket for a thread

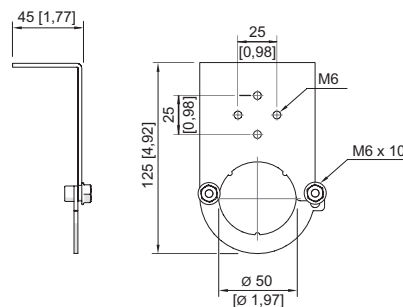
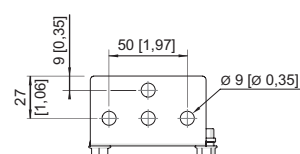

Mounting bracket for surfaces

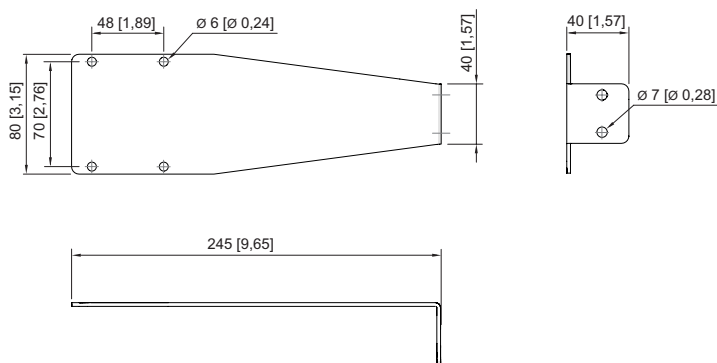





Mounting plate

## Accessories

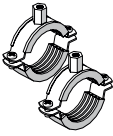
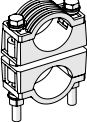
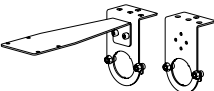
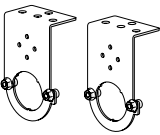
| Plug |  | Art. No. |
|------|--|----------|
|      | 8573/12-200 2-pole, 20 to 25 V, 50 / 60 Hz, 16 A                         | 243197   |
|      | 8573/12-210 2-pole, 20 to 25 V, DC, 16 A                                 | 243203   |
|      | 8573/12-300 3-pole, 20 to 25 V, 50 / 60 Hz, 16 A                         | 243190   |
|      | 8573/12-312 3-pole, 40 to 50 V, 50 / 60 Hz, 16 A                         | 243195   |
|      | 8570/12-304-S-XX-X-XX-XXX 3-pole plug, 100 to 130 V AC, 50/60 Hz, 16 A   | 272896   |
|      | 8570/12-306-S-XX-X-XX-XXX 3-pole plug, 200 to 250 V AC, 50 / 60 Hz, 16 A | 272898   |

6036/1212-053-0121-17 Art. No. 263762

| <b>Mounting bracket</b>  |  | <b>Art. No.</b> |
|--|--|-----------------|
|    | Mounting bracket made of galvanised sheet steel to screw onto thread M8 or M10 (2 pieces)  | 227256          |
|  | Mounting bracket made of stainless steel V4A to screw onto thread M8 or M10 (2 pieces)   | 227257          |
|    | Double plastic mounting clamp for mounting on pipes with a diameter of 45 to 55 mm (screws and nuts made from stainless steel V2A) (2 pieces)                | 254932          |
|    | Set of mounting plate Art. no. 254494 and mounting bracket Art. no. 252940   | 248100          |
|    | Mounting bracket made of stainless steel V4A for fastening on surfaces (2 pieces)  | 252940          |
|   | Mounting bracket made from galvanised sheet steel (x 2 units); for design size 1   | 120535          |
|  | Mounting plate made of stainless steel V4A for terminal box Ex e Series 8010 (for example Art. No. 130724) for fastening on mounting bracket Art. No. 252940 | 254494          |
| <b>Mounting bracket and magnet</b>   |  | <b>Art. No.</b> |
|  | Mounting bracket made from galvanised sheet steel with magnetic base (x 2 units); for design size 1  | 120536          |

We reserve the right to make alterations to the technical data, dimensions, weights, designs and products available without notice. The illustrations cannot be considered binding.