

6050/604-600-6B2-100850-002 Art. No. 265429



- Extremely compact universal light fitting with 4 power classes
- Can be used as a ceiling light fitting, pendant light fitting or floodlight
- Three light distribution curves available: Ultra-wide-beam, wide-beam and medium-wide-beam
- Glare-free thanks to opaque light fitting covering
- Quick, easy installation thanks to Ex e connection chamber
- Universally suitable for use in particularly cold environments as cold as -55 °C
- Suitable for particularly high ambient temperatures up to +70 °C

MY R. STAHL 6050C



The 6050/6 universal spotlight is equipment used for lighting areas, work equipment and objects. It can be used indoors and outdoors. The clear lens is available in a matted version to limit the glare. Using an internal reflector, the universal spotlight can be adapted as a narrow beam, wide beam or a medium-wide beam to suit the lighting task.

Technical Data

Explosion Protection

Application range (zones)	1, 2, 21, 22
IECEX gas explosion protection	Ex db eb op is IIC T4 Gb
IECEX dust explosion protection	Ex tb op is IIIC T110 °C Db
ATEX gas explosion protection	⊕ II 2 G Ex db eb op is IIC T4 Gb
ATEX dust explosion protection	⊕ II 2 D Ex tb op is IIIC T110 °C Db
Certificates and approvals	ATEX IECEX UKEX
Certificates	ATEX (BVIS), Brazil (ULB), IECEX (BVIS), Polen (CNBOP)
Ship approval	DNV
Declaration of conformity	ATEX (EUK)

Electrical Data

AC rated operational voltage	110 ... 277 V
Frequency range	50 – 60 Hz
Start-up current	I _{peak} = 55 A, Delta t = 230 μs

Lighting Data

Number of lamps	1
Lamp wattage	60 W
Lamp type	LED
Lamp	LED
Light colour	5000 K – neutral white
Light distribution	Wide beam
Luminaire efficacy	122 lm/W
Luminous flux	7400 lm
Colour rendering	≥ 80
Colour temperature	5000 K

6050/604-600-6B2-100850-002 Art. No. 265429

Ambient Conditions

Ambient temperature -40 °C ... +60 °C

Mechanical Data

Version	Pendant mounting
Degree of protection (IP)	IP66 / IP68 (10 m)
IP degree of protection (IEC 60598)	IP66/IP68
Enclosure material	Aluminium, Seawater-resistant
Enclosure colour	Standard
Sealing material	Silicone
Silicone-free content	Contains silicone
Protective glass material 2	Pressed glass
Max. solid connection terminals	6 mm ²
Max. finely stranded connection terminals	4 mm ²
Type of connection cable	Finely stranded Solid Finely stranded with clip
Size	1
Width	260 mm
Height	268 mm
Length	310 mm
Reflector	No
Disconnection of the luminaire	No
Weight	7.15 kg
Weight	15.76 lb

Components

Cable glands and entries	1 x M25 x 1.5
Stopping plugs	1 x M25 x 1.5
Wire guard	Yes

Technical Drawings – Subject to Alterations

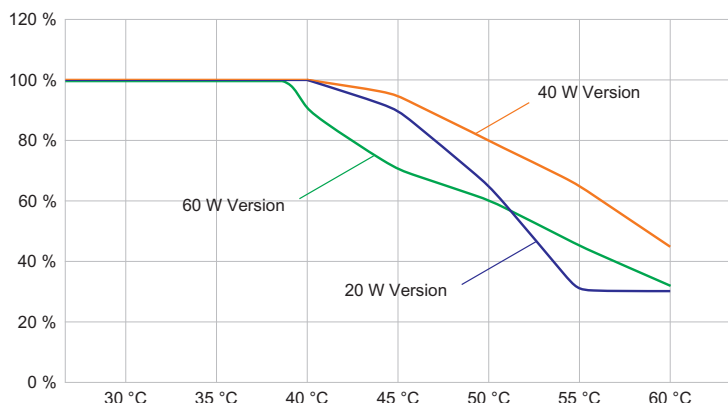

Luminous flux decrease at ambient temperature - variants with DALI

6050/604-600-6B2-100850-002 Art. No. 265429



Luminous flux decrease at ambient temperature - variants without DALI

Light Distribution Curves



cd/klm $\eta = 100\%$
 — C0 - C180 — C90 - C270

Without internal reflector, protection glass clear

Dimensional Drawings (All Dimensions in mm [inches]) – Subject to Alterations

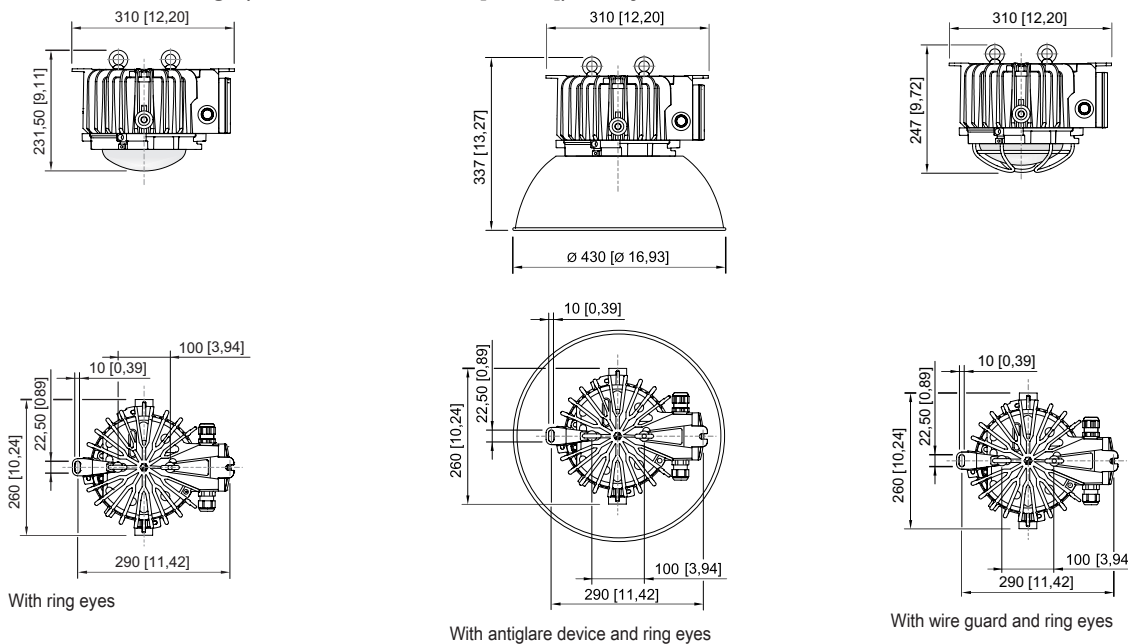

6050/604-600-6B2-100850-002 Art. No. 265429

Accessories

Breather

Art. No.

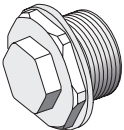
	Thread: M20 x 1.5 (1 piece); for installation in light fittings; made from stainless steel; without jam nut	323702
	Thread: M25 x 1.5 (1 piece); for installation in light fittings; made from stainless steel; without jam nut	296608

Mounting bracket

Art. No.

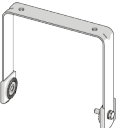
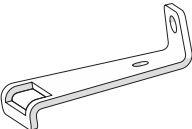
	Complete; made from stainless steel (for subsequent self-mounting) For 6050/6	265877
	The stainless steel mounting fixture is fastened to the enclosure of the pendant light fitting series 6050/6 by means of two stainless steel screws M8.	269716

Pipe clamp

Art. No.

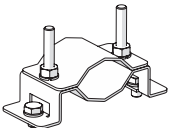
	for pipe R 1 1/4" to 2"	268967
-----------------------------------------------------------------------------------	-------------------------	--------

Plastic cable gland

Art. No.

	8161/7-M25-1707 7 to 17 mm ² 1 piece	229918
	8161/7-M25-1707, Ex e Plastic, M25 x 1.5, cable outer diameter 7 to 17 mm Lot size 50 pieces	239157

Ring bolt

Art. No.

	M8, für 6050/6, direct mounting; 1 pair	265874
	M10, direct mounting in insert nuts; 1 pair	118560

Stopping plug

Art. No.

	8290/3-M25 Plastic, M25 x 1.5 Lot size 1 piece	143524
------------------------------------------------------------------------------------	------------------------------------------------------	--------

Wire guard

Art. No.

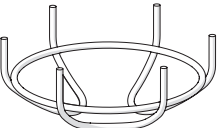
	Complete with mounting parts Material: Stainless steel wire For 6050/6	221774
------------------------------------------------------------------------------------	------------------------------------------------------------------------------	--------

We reserve the right to make alterations to the technical data, dimensions, weights, designs and products available without notice. The illustrations cannot be considered binding.