

Lighting

Linear luminaire With LED

GRP

6002/4148-0100-152-2220-22-8650 Art. No. 267080



- The latest LED technology with a high luminous efficacy and a long service life
- Extremely high luminaire efficacy
- Luminous flux after 100,000 h still 90% of the starting luminous flux
- Optionally with DALI for controlling and monitoring the luminaire
- Optionally addressable for direct actuation of a common battery system

MY R. STAHL 6002D



The linear luminaire with Series 6002/4 LED is ideal for lighting surfaces at a mounting height of up to 10 m. It can also be used to illuminate equipment and objects, both inside and outside. The pole mounting sleeve accessory can be used to easily mount the luminaire on poles. Optionally, the luminaire can be equipped with addressable equipment. It can be used to control and monitor the luminaire for the common battery systems.

Technical Data

Explosion Protection

Ex version	Yes
Application range (zones)	1, 2, 21, 22
IECEX gas certificate	IECEX IBE 14.0035
IECEX gas explosion protection	Ex db eb ib op is IIC T4 Gb
IECEX dust certificate	IECEX IBE 14.0035
IECEX dust explosion protection	Ex tb op is IIIC T100 °C Db
ATEX gas certificate	IBExU 14ATEX1088
ATEX gas explosion protection	⊕ II 2 G Ex db eb ib op is IIC T4 Gb
ATEX dust certificate	IBExU 14ATEX1088
ATEX dust explosion protection	⊕ II 2 D Ex tb op is IIIC T100 °C Db
Certificates and approvals	ATEX IECEX
Certificates	ATEX (IBE), IECEX (IBE), India (PESO)
Declaration of conformity	ATEX (EUK)

Electrical Data

AC rated operational voltage	100 ... 240 V
DC rated operational voltage	110 ... 250 V
Frequency	50 ... 60 Hz
Control gear service life	C10 ≥ 50 h, Ta ≤ 60 °C C10 ≥ 100 h, Ta ≤ 50 °C
LED service life	L90B50 ≥ 100 h

Lighting Data

Number of lamps	1
Lamp wattage	35 W
Lamp	LED
Light colour	6500 K – daylight white

Lighting

Linear luminaire With LED

GRP

6002/4148-0100-152-2220-22-8650 Art. No. 267080



Lighting Data

Light distribution	120°x120° with diffusing glass
Luminaire efficacy	156 lm/W
Luminous flux	5400 lm
Colour rendering	≥ 90
Colour temperature	6500 K

Ambient Conditions

Ambient temperature	-40 °C ... 50 °C (Through wiring max. 3x16 A) -40 °C ... 60 °C (Through wiring max. 3x10 A)
---------------------	--

Mechanical Data

Version	Standard
Translucent cover	Clear
IP degree of protection (IEC 60598)	IP66/IP67
Enclosure material	Polyester resin, Glass fibre reinforced
Enclosure colour	Light grey (RAL 7035)
Insert nut material	Brass
Diffuser	With diffuser
Sealing material	Silicone
Silicone-free content	Contains silicone
Translucent cover material	Polycarbonate
Installed terminal strip	PE + N + L1 + L2 + L3
Max. solid connection terminals	6 mm ²
Max. finely stranded connection terminals	4 mm ²
Type of connection cable	Solid Finely stranded
Size	4
Width	184 mm
Height	125 mm
Length	1310 mm
Impact strength (IEC 62262)	IK10
Disconnection of the luminaire	No
Weight	6.9 kg
Weight	15.21 lb

Components

Threaded plate	2x SS430 stainless steel
Ballast	6045/311-130-10
Through wiring	With 5 conductors 2.5 mm ²
Drilled holes	3 x M20
Cable glands and entries	can be ordered as an accessory
Stopping plugs	Can be ordered as accessories
Accessories	without

Light Distribution Curves

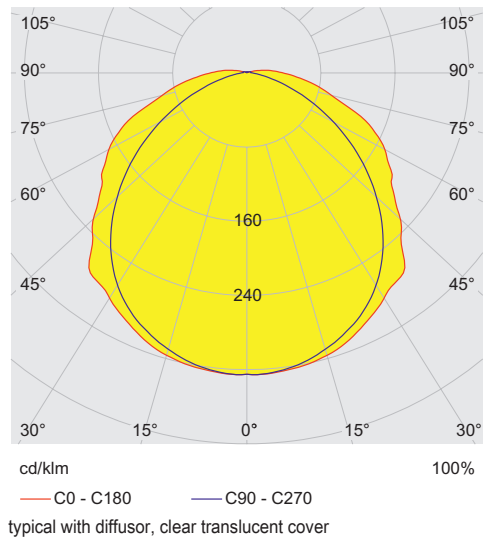

typical with diffusor, clear translucent cover

Dimensional Drawings (All Dimensions in mm [inches]) – Subject to Alterations

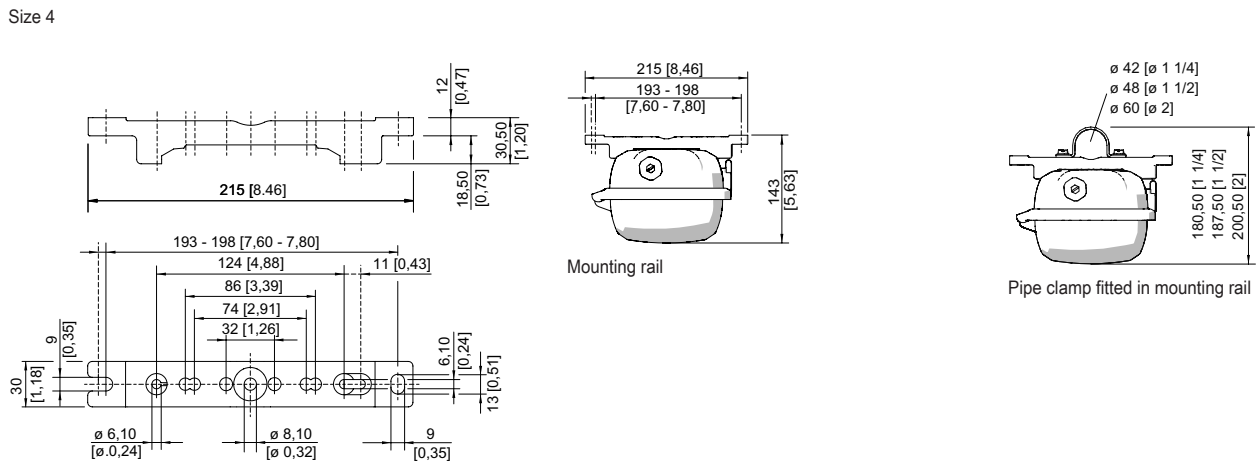
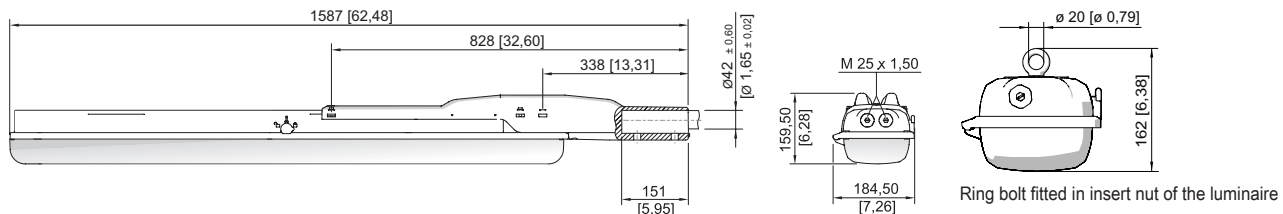
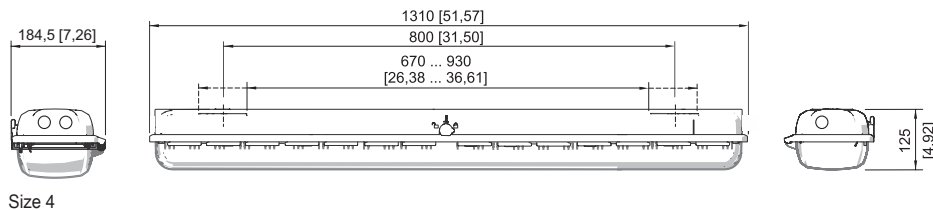

Mounting rail

Lighting

Linear luminaire With LED

GRP

6002/4148-0100-152-2220-22-8650 Art. No. 267080

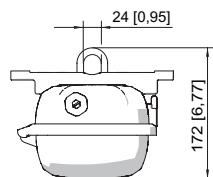

Mounting bracket fitted in mounting rail

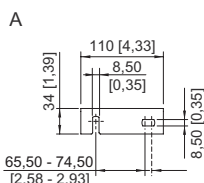
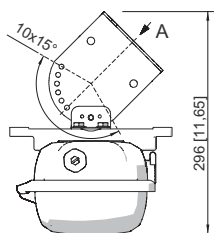

Wall mounting bracket fitted in mounting rail

Accessories

Pole mounting sleeve



for the subsequent mounting on lights size 2 and size 4, completely with assembly parts (for pipe diameter 42 mm)

Art. No.

227512

Adapter plate for mounting EXLUX 6002 on EXLUX 6000 mounting interfaces

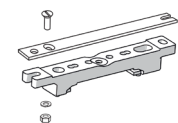

Adapter plate for installation of EXLUX 6002 luminaires onto EXLUX 6000 interfaces

Art. No.

240653

Protection against accidental contact

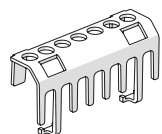

The protection against accidental contact prevents maintenance technicians and electrical installers from accidentally touching conductive parts. The degree of protection is increased to IP20 when the protection against accidental contact is used.

Art. No.

283153

Fall protection

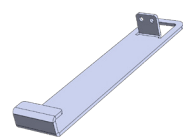

Accessories for mounting an arrester cable

Art. No.

295927

Holder for translucent cover



The fall prevention system for the light fitting cover prevents the light fitting cover from falling accidentally when the light fitting is opened.

Art. No.

226791

Breather

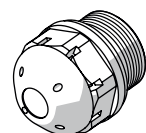

Thread: M25 x 1.5 (20 pieces); without jam nut

M25 x 1.5 in order to avoid condensate formation

Art. No.

285780

115738



Lighting

Linear luminaire With LED

GRP

6002/4148-0100-152-2220-22-8650 Art. No. 267080

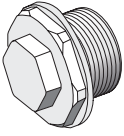
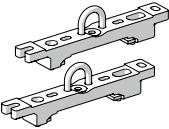
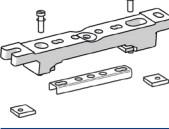
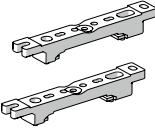

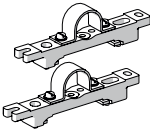
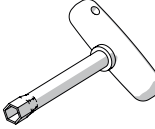
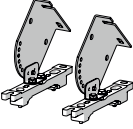
Breather		Art. No.
	Thread: M20 x 1.5 (1 piece); for installation in light fittings; made from stainless steel; without jam nut	323702
	Thread: M25 x 1.5 (1 piece); for installation in light fittings; made from stainless steel; without jam nut	296608
Mounting bracket		Art. No.
	mounting clamp mounted on a mounting rail for a variable mounting distance; 1 pair	222456
Mounting rail		Art. No.
	Mounting accessories for ceiling mounting of EXLUX luminaires with V4A metal insert for reinforcement	325835
	Mounting accessories for ceiling mounting of EXLUX luminaires with V4A metal insert and captive M8 nut	329336
	for a variable mounting distance; 1 pair	222826
Ring bolt		Art. No.
	M8, direct mounting in insert nuts; 1 pair	115736
Pipe clamp		Art. No.
	R 1 1/2"; with mounting rail for a variable mounting distance; material: stainless steel; 1 pair	222459
	R 1 1/4"; with mounting rail for a variable mounting distance; Material: stainless steel; 1 pair	222458
	R 2"; with mounting rail for a variable mounting distance; Material: stainless steel; 1 pair	222460
Box spanner		Art. No.
	M8 / A/F 13; For actuating the central lock	222430
Ceiling and wall mounting bracket		Art. No.
	mounted on a mounting rail for a variable mounting distance; Material: stainless steel; Lamp can be swiveled in steps of 15°; 1 pair	222827

Lighting



Linear luminaire With LED

GRP

6002/4148-0100-152-2220-22-8650 Art. No. 267080

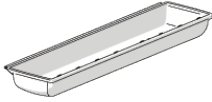

Spare Parts

Cover		Art. No.
	for luminaire size 4	222428
Reflector Plate		Art. No.
	Spare part for 6002 or upgrade 6001 size 4, colour temperature 6500 K	272065

We reserve the right to make alterations to the technical data, dimensions, weights, designs and products available without notice. The illustrations cannot be considered binding.