

8060/2-4-R-60 Art. No. 268417



- Large temperature range of use
- Plastic Ex e enclosure
- Degree of protection IP66/67
- Five different contact versions
- Different actuator versions, which can be displaced by 4 x 90°
- Also applicable as simple apparatus

Webshop **8060B**



Plastic position switch; switch dimensions meet the requirements of DIN EN 50047. It is designed to detect the position of moving components. Certified versions fulfil the requirements for safety switches as set out in EN 13849-1 and have positive-opening contacts in accordance with EN 60947-5-1.

### Technical Data

#### Explosion Protection

Scope of validity	European Union (ATEX)
Application range (zones)	1 2 21 22
IECEX gas certificate	IECEX BVS 16.0066
IECEX gas explosion protection	Ex db eb IIC T6 Gb
IECEX dust certificate	IECEX BVS 16.0066
IECEX dust explosion protection	Ex tb IIIC T80 °C Db
ATEX gas certificate	BVS 16 ATEX E 100
ATEX gas explosion protection	⊕ II 2 G Ex db eb IIC T6 Gb
ATEX dust certificate	BVS 16 ATEX E 100
ATEX dust explosion protection	⊕ II 2 D Ex tb IIIC T80 °C Db
Certificates	ATEX (BVS), Canada (CSA), China (CQST), IECEX (BVS), India (PESO), Korea (KGS), USA (CSA)
Declaration of Conformity	ATEX (EUK), ATEX (Simple apparatus), Declaration of Conformity (ATEX)

#### Electrical Data

Rated operational voltage DC	125 V
AC operating voltage (equal potential)	400 V
AC operating voltage (unequal potential)	250 V
Rated insulation voltage	500 V
Rated insulation voltage note	(for simple apparatus: 40 V)
Rated operational current max.	4 A
Rated operational current note	(for simple apparatus: 200 mA): inductance $L_i$ and capacitance $C_i$ are negligible
Electrical service life	Max. 10 <sup>6</sup> operating cycles
Mechanical service life	Max. 10 <sup>6</sup> operating cycles
Rated surge voltage	6 kV

8060/2-4-R-60 Art. No. 268417

**Electrical Data**

Short-circuit protection, max.	6 A
Tripping characteristic	gL/gG
Maximum operating frequency	1800 operating cycles/h
Switching function	Slow-action contact

**Ambient Conditions**

Ambient temperature	-60 °C ... +55 °C (Max. 4 A) -60 °C ... +60 °C (Max. 2 A)
---------------------	--

**Mechanical Data**

Version	2nd generation
Degree of protection (IP)	IP66
Degree of protection (IP) (IEC 60529)	IP67
Enclosure material	Thermoplast GF, impact resistant
Enclosure colour	Black
Cover material	Duroplast GF, impact resistant
Contact material	Silver-nickel
Solid connection cross section	0.75 – 1.5 mm <sup>2</sup>
Finely stranded connection cross section	0.75 – 1.5 mm <sup>2</sup>
Positive opening operation	No
Positive opening contact note	Not suitable for safety circuits!
Number of NOs	2
Actuator	Roller plunger
Clamping range	7 ... 13 mm
Type of connection cable	Finely stranded
Contacts	2 NO
Seal	Silicone
Packaging unit	1
Weight	100 g
Weight	0.22 lb

**Mounting / Installation**

Connection	Cable entry 8161 1xM20x1.5
------------	----------------------------

**Components**

Cable glands and entries	1 x M20 Ø 7 to 13 mm
Material cable gland	Polyamide, Glass fibre reinforced

**Technical Drawings – Subject to Alterations**

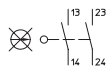

Slow-action contact 2 NO  
8060/-4; 807./2-4

8060/2-4-R-60 Art. No. 268417

Dimensional Drawings (All Dimensions in mm [inches]) – Subject to Alterations

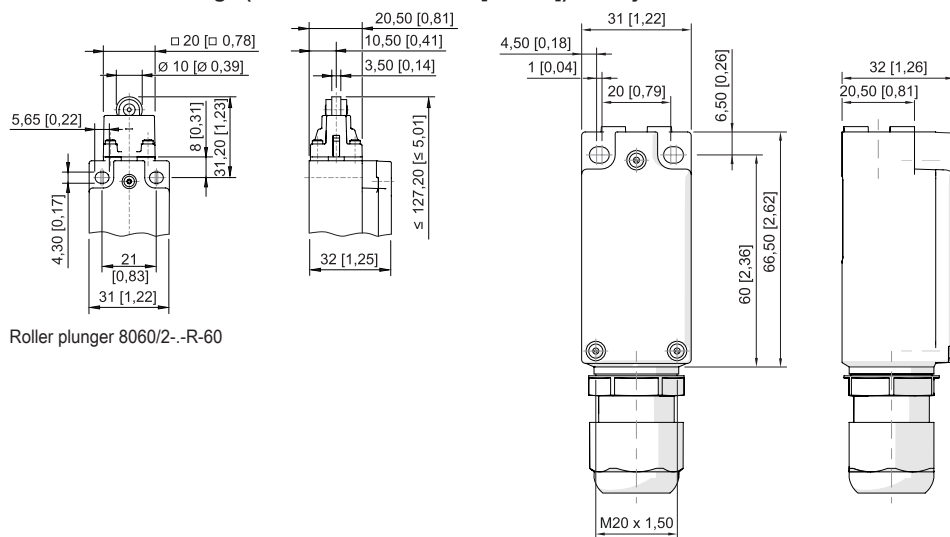

Roller plunger 8060/2-.-R-60

Accessories

Actuator

Art. No.

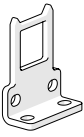
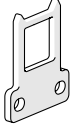
	Angled actuator, for 8060/2-.-AZ	257053
	Straight actuator, for 8060/2-.-AZ	257052

Cable gland made of plastic

Art. No.

	8161/7-M20-1307, Ex e Plastic, M20 x 1.5, cable outer diameter 7 to 13 mm Lot size 50 pieces	239172
--	--	--------

Spare Parts

Actuator

Art. No.

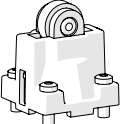
	Roller plunger actuator	257054
--	-------------------------	--------

Contact element

Art. No.

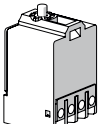
	2 NO slow-action contact 8080/1-4	132533
--	-----------------------------------	--------

8060/2-4-R-60 Art. No. 268417

---

We reserve the right to make alterations to the technical data, dimensions, weights, designs and products available without notice. The illustrations cannot be considered binding.