

Control and signalling devices

Control devices for panel mounting

Ex e

8003/113-001-6 Art. No. 269819



PanSiG



- Flexible configuration thanks to pushbutton, mushroom push-button, mushroom stay-put button, mushroom stay-put button with key lock, key-operated button and key-operated switch
- Easy to install using a single hole (D 30)
- Codable "latching", "spring return" and "key not removable" functions
- Plug-in connection with 6 m connection cable

MY R. STAHL 8003E



R. STAHL Series 8003 control buttons/switches for panel mounting switch load, control and signal circuits up to 6 A. Depending on the type, they are fully or incompletely explosion-protected equipment with corresponding requirements for installation. As an option, various actuators are available.

Technical Data

Explosion Protection

Area of application	European Union (ATEX) IECEX CCC
Application range (zones)	1, 2, 21, 22
IECEX gas certificate	IECEX PTB 06.0065X
IECEX gas explosion protection	Ex db eb IIC T6 Gb
IECEX dust certificate	IECEX PTB 06.0065X
IECEX dust explosion protection	Ex tb IIIC T80 °C Db
ATEX gas certificate	PTB 02 ATEX 1057 X
ATEX gas explosion protection	⊕ II 2 G Ex db eb IIC T6 Gb
ATEX dust certificate	PTB 02 ATEX 1057 X
ATEX dust explosion protection	⊕ II 2 D Ex tb IIIC T80 °C Db
Certificates	ATEX (PTB), China (CQST), IECEX (PTB), Korea (KGS)
Declaration of conformity	ATEX (EUK), China (CCC)
Notes	Product label may vary. Series devices are labelled with ATEX and IECEX.

Electrical Data

AC rated operational voltage	500 V
Rated operational current	6 A
Rated operational current	6 A
Switching capacity AC-12	500 V / 6 A / max. 3000 VA
Switching capacity AC-15	400 V / 6 A / max. 1250 VA
Switching capacity DC-13	110 V / 1 A / max. 110 W
Switching capacity DC-13 2 contact elements in series	60 V/6 A

Ambient Conditions

Ambient temperature	-20 °C ... 60 °C
Ambient temperature	-4 °F ... +140 °F

Control and signalling devices

Control devices for panel mounting



Ex e

8003/113-001-6 Art. No. 269819

Mechanical Data

Degree of protection (IP) (IEC 60529)	Reverse side IP65, front side IP66
Enclosure material	Polyamide
Contact material	Silver-nickel
Silicone-free	Yes
Number of NCs	1
Number of NOs	1
Conductor length	6 m
Conductor length, inches	236.22 in
Connection cross-section	0.75 ... 1.5 mm ²
Connection cross-section AWG	20 AWG ... 14 AWG
Type of connection cable	ÖLFLEX 4x1 mm ²
Mounting depth	130 mm
Mounting depth in inches	5.12 in
Service life, min.	10 ⁵ operating cycles
Weight	125 g

Mounting / Installation

Tightening torque	3 N · m
Tightening torque lbf in	26.55 lbf in

Components

Actuator	Pushbutton
Entry 1	8161/7-M16-0902
Entry 1 type	Polyamide cable gland, black

Technical Drawings – Subject to Alterations

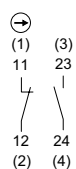

Schematic 8003/113
 NO/positive opening NC
 The numbers in brackets correspond to the core marking

Dimensional Drawings (All Dimensions in mm [inches]) – Subject to Alterations

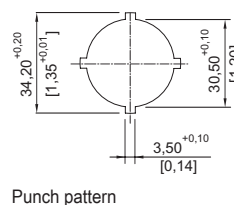
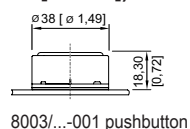
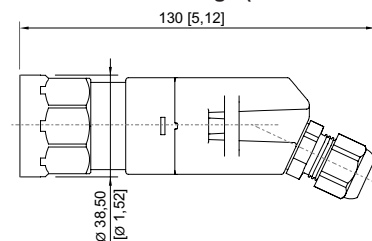

Control and signalling devices

Control devices for panel mounting

Ex e

8003/113-001-6 Art. No. 269819

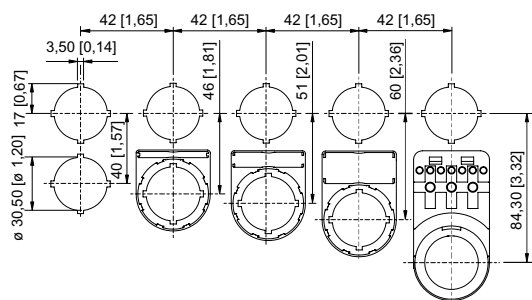

Cut-out with/without additional designation plate

Accessories

Actuators



Pushbutton

Art. No.

155525

Spare Parts

Label holder



Label holder, size 1, without insert disc
Labelling: 1-line
can be installed in dia. 30.5 mm drilled holes for actuators

Art. No.

155632



Label holder, size 2, without insert disc
Labelling: 1- or 2-line
can be installed in dia. 30.5 mm drilled holes for actuators

Art. No.

155687

Locking devices



8602A0753 H24 for not actuated pushbutton/selector switch
BG001, BG005

Art. No.

155372

Label holder



Label holder, size 3, without insert disc
Labelling: 1-, 2- or 3-line
can be installed in dia. 30.5 mm drilled holes for actuators

Art. No.

155844

Locking devices



8602A0754 for actuated pushbutton/selector switch
BG001, BG005

Art. No.

155402











Control and signalling devices

Control devices for panel mounting



Ex e

8003/113-001-6 Art. No. 269819

Designation plates for pushbuttons and selector switches		Art. No.
	Colour: White Text: START	155889
	Colour: Blue Text: RESET	155894
	Colour: Green Text: START	155721
Locking devices		Art. No.
	8602A0755 for not actuated pushbutton/selector switch BG001, BG005	155431
Designation plates for pushbuttons and selector switches		Art. No.
	Colour: Black Text: Ab	155886
	Colour: Black Text: Auf	155883
Protective collar		Art. No.
	8602A0751 metal for pushbutton/selector switch/mushroom stay-put button with key lock/mushroom stay-put button/mushroom pushbutton dia. 39 BG001, BG003, BG005, BG008, BG009, BG010, BG012	155326
Designation plates for pushbuttons and selector switches		Art. No.
	Colour: Black Symbol: Arrow	155749
	Colour: Black Symbol: Arrow	155761
	Colour: Black Text: Links	155827

Control and signalling devices

Control devices for panel mounting



Ex e

8003/113-001-6 Art. No. 269819

Designation plates for pushbuttons and selector switches

Art. No.

	Colour: Black Text: Rechts	155837
	Colour: Black Text: Open	155868
	Colour: Black Text: CLOSE	155878
	Colour: Black Text: Zu	155874
	Colour: Red Text: OFF	155654
	Colour: Green Text: ON	155671
	Colour: Red Text: AUS	155634

Insert discs for label holder

Art. No.

	One-line Plain Material: PVC Colour: White Self-adhesive	238271
--	--	--------

Designation plates for pushbuttons and selector switches

Art. No.

	Colour: Black Text: AUS	155806
--	----------------------------	--------

Insert discs for label holder

Art. No.

	Two-line Plain Material: PVC Colour: White Self-adhesive	238272
--	--	--------

Control and signalling devices

Control devices for panel mounting



Ex e

8003/113-001-6 Art. No. 269819

Designation plates for pushbuttons and selector switches

Art. No.

	Colour: Black Text: EIN	155862
--	----------------------------	--------

Insert discs for label holder

Art. No.

	Three-line Plain Material: PVC Colour: White Self-adhesive	238273
--	--	--------

Designation plates for pushbuttons and selector switches

Art. No.

	Colour: Black Text: STOP	155795
	Colour: Black Text: I	155846
	Colour: Green Text: I	155689
	Colour: White Text: I	155892
	Colour: Black Text: II	155854
	Colour: Green Text: II	155706
	Colour: Red Text: O	155596
	Colour: Black Text: O	155783

Control and signalling devices

Control devices for panel mounting







Ex e

8003/113-001-6 Art. No. 269819



Designation plates for pushbuttons and selector switches

Art. No.

	Colour: Black Text: I O	155771
	Colour: Blue Blank disc without text	155911
	Colour: Yellow Blank disc without text	155914
	Colour: Red Blank disc without text	155897
	Colour: Green Blank disc without text	155901
	Colour: White Blank disc without text	155908
	Colour: Black Blank disc without text	155905

We reserve the right to make alterations to the technical data, dimensions, weights, designs and products available without notice. The illustrations cannot be considered binding.