

6050/604-801-7B2-100850-002 Art. No. 270021



- Extremely compact universal light fitting with 4 power classes
- Can be used as a ceiling light fitting, pendant light fitting or floodlight
- Three light distribution curves available: Ultra-wide-beam, wide-beam and medium-wide-beam
- Glare-free thanks to opaque light fitting covering
- Quick, easy installation thanks to Ex e connection chamber
- Universally suitable for use in particularly cold environments as cold as -55 °C
- Suitable for particularly high ambient temperatures up to +70 °C

MY R. STAHL 6050C



The 6050/6 universal spotlight is equipment used for lighting areas, work equipment and objects. It can be used indoors and outdoors. The clear lens is available in a matted version to limit the glare. Using an internal reflector, the universal spotlight can be adapted as a narrow beam, wide beam or a medium-wide beam to suit the lighting task.

### Technical Data

#### Explosion Protection

Application range (zones)	1 2 21 22
IECEX gas certificate	IECEX EPS 17.0093
IECEX gas explosion protection	Ex db eb op is IIC T4 Gb
IECEX dust certificate	IECEX EPS 17.0093
IECEX dust explosion protection	Ex tb op is IIIC T110 °C Db
ATEX gas certificate	EPS 17 ATEX 1 181
ATEX gas explosion protection	Ex II 2 G Ex db eb op is IIC T4 Gb
ATEX dust certificate	EPS 17 ATEX 1 181
ATEX dust explosion protection	Ex II 2 D Ex tb op is IIIC T110 °C Db
Certificates and approvals	ATEX IECEX UKEX
Certificates	ATEX (BVIS), Brazil (ULB), IECEX (BVIS), Polen (CNBOP)
Ship approval	DNVGL
Declaration of Conformity	ATEX (EUK), Declaration of Conformity (AUS)

#### Electrical Data

Rated operational voltage AC	220 – 240 V
Interfaces	DALI
Frequency range	50 – 60 Hz
Start-up current	I <sub>peak</sub> = 57 A, Delta t = 210 µs

#### Lighting Data

Number of lamps	1
Lamp wattage	80 W
Lamp type	LED
Lamp	LED

6050/604-801-7B2-100850-002 Art. No. 270021

**Lighting Data**

Light colour	5000 K – neutral white
Light distribution	Wide beam
Luminaire efficacy	113 lm/W
Luminous flux	8800 lm
Colour rendering	≥ 80
Colour temperature	5000 K

**Ambient Conditions**

Ambient temperature	-40 °C ... +70 °C
---------------------	-------------------

**Mechanical Data**

Version	Pendant mounting
Degree of protection (IP)	IP66 / IP68 (10 m)
Enclosure material	Aluminium, Seawater-resistant
Enclosure colour	Standard
Sealing material	Silicone
Silicone-free content	Contains silicone
Protective glass material 2	Pressed glass
Max. solid connection terminals	6 mm <sup>2</sup>
Max. finely stranded connection terminals	4 mm <sup>2</sup>
Type of connection cable	Solid Finely stranded Finely stranded with clip
Size	1
Width	260 mm
Height	231.5 mm
Length	310 mm
Reflector	No
Weight	7.15 kg
Weight	15.76 lb
Disconnection of the luminaire	No

**Components**

Cable glands and entries	1 x M25 x 1.5
Stopping plugs	1 x M25 x 1.5
Wire guard	Yes

6050/604-801-7B2-100850-002 Art. No. 270021

### Technical Drawings – Subject to Alterations



Luminous flux decrease at ambient temperature - variants with DALI



Luminous flux decrease at ambient temperature - variants without DALI

### Light Distribution Curves

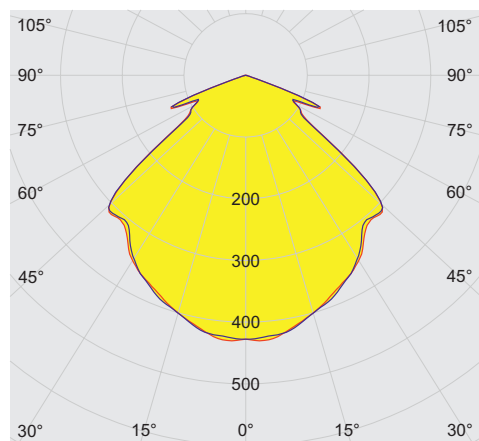

Without internal reflector, protection glass clear

6050/604-801-7B2-100850-002 Art. No. 270021

### Dimensional Drawings (All Dimensions in mm [inches]) – Subject to Alterations

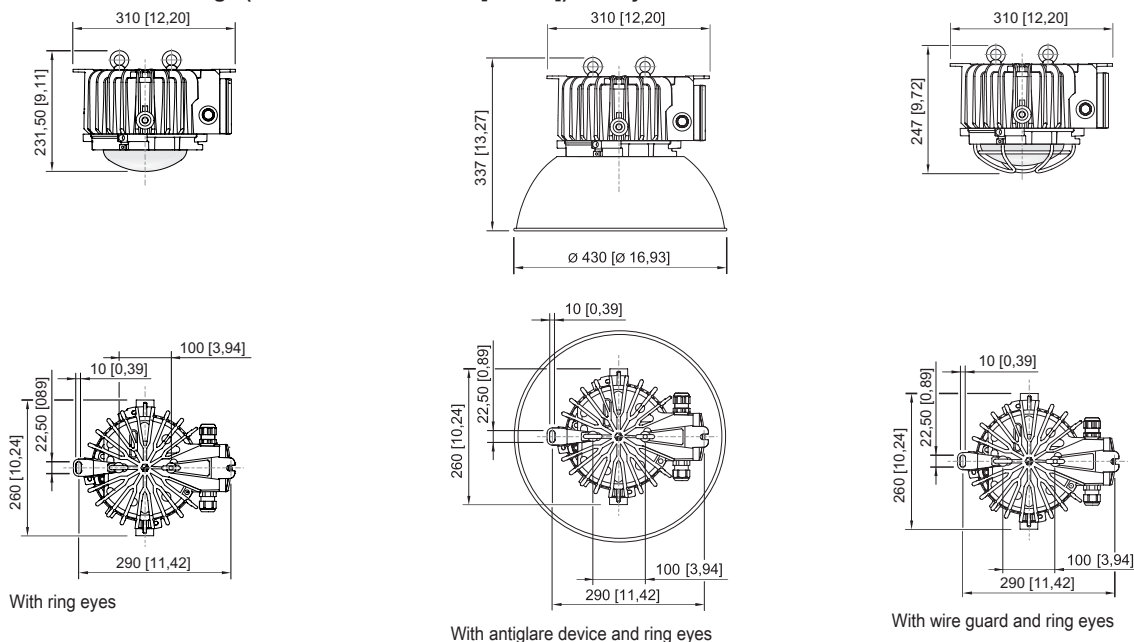

## Accessories

### Antiglare device / reflector

	Complete with mounting parts Material: Aluminium For 6050/11 and 6050/6	<b>Art. No.</b> 118565
--	---	---------------------------

### Cable gland made of plastic

	8161/7-M25-1707, Ex e Plastic, M25 x 1.5, cable outer diameter 7 to 17 mm Lot size 50 pieces	<b>Art. No.</b> 239157
--	--	---------------------------

### External reflector



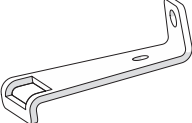

	Narrow-beam Complete with mounting parts Material: High-gloss anodised aluminium For 6050/11	<b>Art. No.</b> 118558
--	---	---------------------------

### Mounting bracket

	Complete; made from stainless steel (for subsequent self-mounting) For 6050/6	<b>Art. No.</b> 265877
--	--	---------------------------

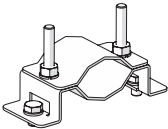
	The stainless steel mounting fixture is fastened to the enclosure of the pendant light fitting series 6050/6 by means of two stainless steel screws M8.	269716
--	---	--------

6050/604-801-7B2-100850-002 Art. No. 270021

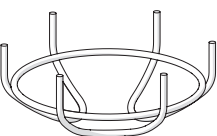
Pipe clamp		Art. No.
	for pipe R 1 1/4" to 2"	268967
Plastic cable gland		Art. No.
	8161/7-M25-1707 7 to 17 mm <sup>2</sup> 1 piece	229918
Ring bolt		Art. No.
	M8, für 6050/6, direct mounting; 1 pair	265874
	M10, direct mounting in insert nuts; 1 pair	118560
Stopping plug		Art. No.
	8290/3-M25 Plastic, M25 x 1.5 Lot size 1 piece	143524
Wire guard		Art. No.
	Complete with mounting parts Material: Stainless steel wire For 6050/6	221774

We reserve the right to make alterations to the technical data, dimensions, weights, designs and products available without notice. The illustrations cannot be considered binding.