

Installation equipment

Mushroom stay-put button With key

EMERGENCY STOP

8602C3-009-S .. MS3 Art. No. 270416

STAHL



- Pushbutton, mushroom pushbutton, mushroom stay-put button with key lock, mushroom stay-put button, twin pushbutton and illuminated pushbutton, rotary actuator, key-operated switch, potentiometer bezel and indicator lamp bezel
- One axial actuator can actuate up to four Series 8082 contact elements
- Key-operated switches and rotary switches codable at any time as "latching/spring return" or "key not removable"

MY R. STAHL 8602A



Thanks to their special technical features, the actuators from the 8602/3 series can withstand the most extreme conditions. In addition to the application option for use in ambient temperatures from -60 °C to +70 °C, the IP degree of protection, IP66, is maintained in accordance with EN 60529. It is also possible to actuate up to four contact elements from the 8082 series with a single axial actuator from the 8602/3 series.

The coding option of the key switches and rotary switches is innovative and one-of-a-kind. Integrated coding allows you to adjust the "latching/spring return" and/or "key not removable" functions at any time without additional accessories. A versatile set of accessories consisting of label holders and locking devices is available.

Technical Data

Explosion Protection

Application range (zones)	1, 2, 21, 22
IECEX gas certificate	IECEX PTB 13.0047U
IECEX gas certificate	IECEX PTB 13.0047U
IECEX gas explosion protection	Ex eb IIC Gb
IECEX dust certificate	IECEX PTB 13.0047 U
IECEX dust explosion protection	Ex tb IIIC Db
ATEX gas certificate	PTB 13 ATEX 1019 U
ATEX gas certificate	PTB 13 ATEX 1019 U
ATEX gas explosion protection	Ex II 2 G Ex eb IIC Gb
ATEX dust certificate	PTB 13 ATEX 1019 U
ATEX dust explosion protection	Ex II 2 D Ex tb IIIC Db
UL gas certificate	E182378 V4 S2
Inmetro gas certificate	UL-BR 14.0380U
Inmetro dust certificate	UL-BR 14.0380U
Certificates	ATEX (PTB), Brazil (ULB), Canada / USA (UL), Canada (UL), IECEX (PTB), India (PESO), Korea (KGS)

Functional Safety

SIL-capable	Only with contact elements 8082/1, 8082/2 and 8208/24-15
-------------	--

Ambient Conditions

Ambient temperature	-60 °C ... 70 °C
Ambient temperature	-76 °F ... +158 °F
Storage temperature	-60 °C ... 70 °C
Storage temperature	-76 °F ... +158 °F

Installation equipment

Mushroom stay-put button With key

EMERGENCY STOP

8602C3-009-S .. MS3 Art. No. 270416



Ambient Conditions

Use at the height of	< 2000 m
Max. operating altitude	2000 m
Degree of contamination	3

Mechanical Data

Version	with key lock
Degree of protection (IP)	IP66
Note on degree of protection	According to IEC/EN 60529
Enclosure material	Polyamide
Silicone-free	No
Assembly	009
Diameter	39 mm
Service life, min.	10 ⁵ actuations
Impact strength (IEC 60079)	7 J
Impact strength (IEC 62262)	min. IK08
Colour	Yellow/red
Fastening	Thread type
Designation plate	With yellow backing plate
Seal	Silicone
Closing	MS3
Packaging unit	1
Weight	75 g
Weight	0.17 lb
Description note	Two keys enclosed.

Mounting / Installation

Mounting type	Front panel mounting
Tightening torque	3 Nm
Tightening torque lbf in	26.55 lbf in

Technical Drawings – Subject to Alterations

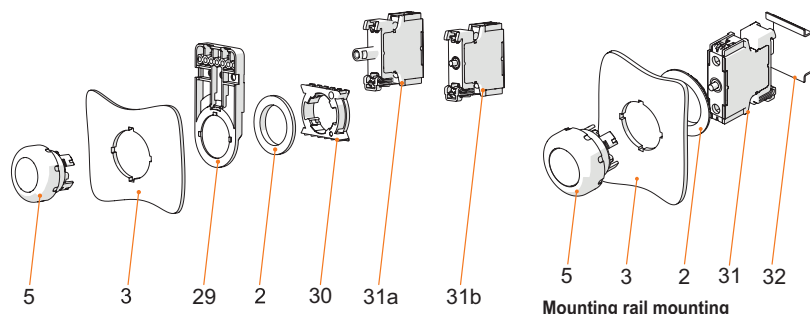

Front installation mounting with Series 8010/6 indicator lamp and Series 8082/3 contact element

Mounting rail mounting

Key

- 2 = jam nut (order no. 205592)
- 3 = installation wall (wall thickness max. 5 mm [0.197 inch])
- 5 = actuator with seal
- 29 = support for cable duct (optional) (order no. 248673)
- 30 = adaptor (order no. 227038)
- 31a = built-in element: LED element 8010/6
- 31b = built-in element: Contact element 8082/3

Key

- 2 = jam nut (order no. 205592)
- 3 = installation wall (wall thickness max. 5 mm [0.197 inch])
- 5 = actuator with seal
- 31 = built-in element
- 32 = TS35 mounting rail

Installation equipment

Mushroom stay-put button With key

EMERGENCY STOP

8602C3-009-S .. MS3 Art. No. 270416



Dimensional Drawings (All Dimensions in mm [inches]) – Subject to Alterations

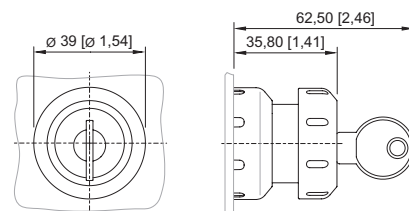
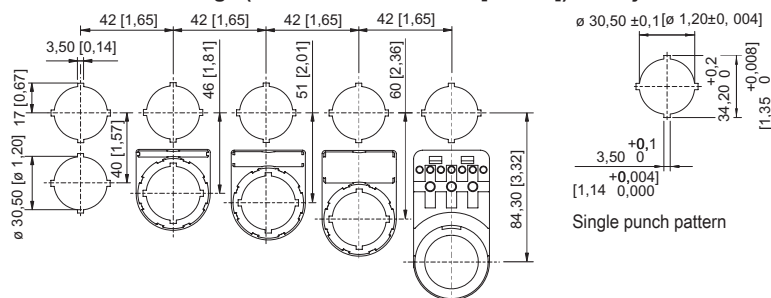

8602/3-006 red/black mushroom stay-put button with key lock
 8602/3-009 red/yellow mushroom stay-put button with key lock
 Actuator with axial actuation

Cut-out with/without additional designation plate

Accessories

Spare key





Closing MS3

Art. No.

272646

Spare Parts

Insert discs for label holder

		Art. No.
	One-line Plain Material: PVC Colour: White Self-adhesive	238271
	Two-line Plain Material: PVC Colour: White Self-adhesive	238272
	Three-line Plain Material: PVC Colour: White Self-adhesive	238273

Label, yellow, general



for $\varnothing 39$ actuator (EM-STOP)

Art. No.

223571

Closing part



8602C3-733-B
 for closing unused holes in cover, dia. 30.5 mm, NBR

8602C3-733-S
 for closing unused holes in cover, dia. 30.5 mm, silicone

Art. No.

244306

244307

Installation equipment

Mushroom stay-put button With key

EMERGENCY STOP

8602C3-009-S .. MS3 Art. No. 270416



Protective collar

Art. No.



8602C3-751 plastic/red for mushroom stay-put button with key lock/mushroom stay-put button dia. 39
BG006, BG009, BG010, BG012

257707



8602C3-751 plastic/yellow for mushroom stay-put button with key lock/mushroom stay-put button dia. 39
BG006, BG009, BG010, BG012

257708

Label holder

Art. No.



Size 1, without insert disc, 1-line label
for actuators Ø 39

223566



Size 2, without insert disc, 1- or 2-line label
for actuators Ø 39

223567



Size 3, without insert disc, 1-, 2- or 3-line label
for actuators Ø 39

223568

Special key

Art. No.



for tightening plastic locking nut

169101

Pressure plates

Art. No.



Dia. 37 mm
Three contact elements

215436

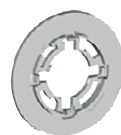

Dia. 48.5 mm
Four contact elements

215437

Holder for front installation

Art. No.



8602/3 holder for cable duct

248673

Installation equipment

Mushroom stay-put button With key

EMERGENCY STOP

8602C3-009-S .. MS3 Art. No. 270416



Adaptor for front installation

Art. No.



8602/3 Front installation for indicator lamp series 8010/6 and contact element series 8082/3

227038

8082/3 Contact element

Art. No.



For NC front installation

240898

for NO contact front installation

240899

We reserve the right to make alterations to the technical data, dimensions, weights, designs and products available without notice. The illustrations cannot be considered binding.