

8579/31-506 Art. No. 270900



- Reliable load disconnect switch with easily visible, lockable handle and display of the switching position
- An integrated auxiliary contact for control and signalling purposes, can be optionally enhanced using pluggable Ex e or Ex i auxiliary contacts that are easily retrofittable
- Large temperature range of use
- High mechanical impact and shock resistance
- Perfect protection against penetration of liquids and dusts
- 3D data for download on the website

MY R. STAHL 8579A



The R. STAHL Series 8579/31 sockets for Zone 1/21 in 4- and 5-pole versions have full AC-3 switching capacity up to 63 A. The high degree of protection (IP66) ensures maximum protection against the ingress of dust and water in any application situation. Self-cleaning lamellar contacts provide optimum contact and the plugs can be inserted and removed in the zero position quickly and easily. The load disconnect switch, with a mechanical locking device and a handle that can be locked in the 0 or I position, is an additional safety feature.

### Technical Data

#### Explosion Protection

Area of application	European Union (ATEX) IECEX China (CQST)
Scope of validity Note	Other country markings available on request
Application range (zones)	1, 2, 21, 22
IECEX gas certificate	IECEX PTB 06.0020
IECEX gas explosion protection	Ex db eb IIC T6 ... T5 Gb
IECEX dust certificate	IECEX PTB 06.0020
IECEX dust explosion protection	Ex tb IIIC T60 °C / T75 °C Db
ATEX gas certificate	PTB 01 ATEX 1150
ATEX gas explosion protection	Ex II 2 G Ex db eb IIC T6 ... T5 Gb
ATEX dust certificate	PTB 01 ATEX 1150
ATEX dust explosion protection	Ex II 2 D Ex tb IIIC T60 °C / T75 °C Db
Certificates	ATEX (PTB), Brazil (ULB), China (CQST), IECEX (PTB), Korea (KGS), Taiwan (ITRI)
Declaration of Conformity	ATEX (EGK), China (CCC)

#### Electrical Data

Rated operational voltage AC	200/346 to 240/415 V AC
Rated operational current	max. 63 A
Electrical service life	> 2x10 <sup>4</sup> switching cycles
Mechanical service life	> 2x10 <sup>4</sup> switching cycles
Type of voltage	Low voltage

# Installation equipment

## 63 A wall-mounting socket



8579/31-506 Art. No. 270900

### Electrical Data

Switching capacity main contacts	AC-3 690 V, 63 A 18.5 kW: 220/230/240 V 30 kW: 380/400/415 V 37 kW: 500 V 55 kW: 690 V
Auxiliary contacts	2 (1 NO + 1 NC)
Frequency range	50 / 60 Hz

### Device Specific Data

Back-up fuse with thermal protection	80 A gG
Back-up fuse without thermal protection	63 A gG

### Ambient Conditions

Ambient temperature	-45 °C to +55 °C
Ambient temperature	-49 °F to +131 °F

### Mechanical Data

Degree of protection IP (IEC 60529)	IP66
IP degree of protection (IEC 60079)	IP66
Enclosure material	Polyester, Glass fibre reinforced
Silicone-free	No
Multiple conductor connection	2 x 16 mm <sup>2</sup>
Multiple conductor connection AWG	2 x AWG 6
Finely stranded connection cross-section	1 x 16 mm <sup>2</sup> ... 1 x 50 mm <sup>2</sup>
Finely stranded connection cross-section AWG	1 x AWG 6 ... 1 x AWG 1/0
Stranded connection cross-section	1 x 16 mm <sup>2</sup> ... 1 x 50 mm <sup>2</sup>
Stranded connection cross-section AWG	1 x AWG 6 ... 1 x AWG 1/0
Width	180 mm
Width, inches	7.09 in
Height	212 mm
Height in inches	8.36 in
Length	413 mm
Length in inches	16.27 in
Impact strength (IEC 60079)	7 J
Impact strength (IEC 62262)	IK10
Colour code	Red
Coding (clock hour position)	6
Lockable in	in 0- and I-position
Series	SolConeX
Detailed number of poles	3 P + N + PE
Weight	8.2 kg
Weight	18.08 lb

### Mounting / Installation

Connection	Screw terminal
------------	----------------

### Components

Cable entry note	Entry 1: Bottom left Entry 2: Bottom right
------------------	---

# Installation equipment

## 63 A wall-mounting socket



8579/31-506 Art. No. 270900

### Components

Entry 1 model	8161/7-M50-3516-LT
Entry 1 type	Polyamide cable gland
Entry 1	M50 x 1.5
Entry 1 clamping range	16 – 35 mm
Entry 1 clamping range, inch	0.63 – 1.38 in
Metal entry possible 1	No
Entry 2 model	8290/3-M25
Entry 2 type	Polyamide stopping plug
Entry 2	M25 x 1.5
Metal entry possible 2	No

### Technical Drawings – Subject to Alterations

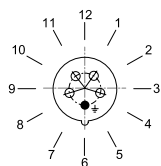

Position of clock hour position  
Example: 6 h position

### Dimensional Drawings (All Dimensions in mm [inches]) – Subject to Alterations

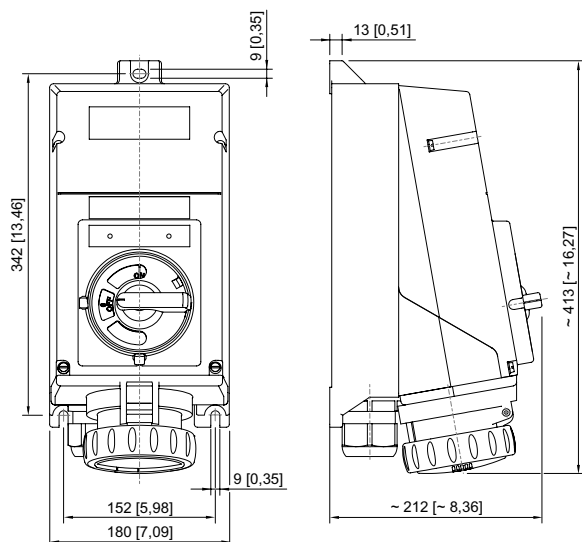

Wall-mounting socket

### Accessories

Auxiliary contact

Art. No.

# Installation equipment

## 63 A wall-mounting socket



8579/31-506 Art. No. 270900

	2 NC (8080/1-3) 250 V AC/DC Max. 6 A 1.5 to 2.5 mm <sup>2</sup> , solid/finely stranded The switching function of the auxiliary contact depends on the installation slot used. Left and right: Synchronising	168356
	1 NC + 1 NO (8080/1-1) 250 V AC/DC Max. 6 A 1.5 to 2.5 mm <sup>2</sup> , solid/finely stranded The switching function of the auxiliary contact depends on the installation slot used. Left: Delayed (ON), leading (OFF) Right: Synchronising	168351
	2 NO (8080/1-4) 250 V AC/DC Max. 6 A 1.5 to 2.5 mm <sup>2</sup> , solid/finely stranded The switching function of the auxiliary contact depends on the installation slot used. Left and right: Synchronising	168353

### Cable gland made of plastic

Art. No.

	8161/7-M25-1707, Ex e Plastic, M25 x 1.5, cable outer diameter 7 to 17 mm Lot size 50 pieces	239157
---	--	--------

### Ex i cover

Art. No.

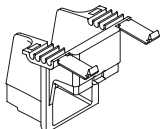
	Ex i cover for auxiliary contacts for use in Ex i electrical circuits	168855
--	---	--------

### Plastic cable gland

Art. No.

	8161/7-M50-3516, Ex e Plastic, M50 x 1.5, cable outer diameter 16 to 35 mm Lot size 4 pieces	239160
--	--	--------

### Stopping plug

Art. No.

	8290/3-M25 Plastic, M25 x 1.5 Lot size 1 piece	143524
--	--	--------

## Spare Parts

### Auxiliary contact key

Art. No.

	For removing installed auxiliary contacts	201909
--	---	--------

# Installation equipment

## 63 A wall-mounting socket



8579/31-506 Art. No. 270900

### Repair set for Series 8579 sockets

Art. No.

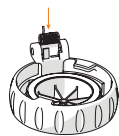

Repair set 8579 hinged cover, red

275508

### Switch insert

Art. No.

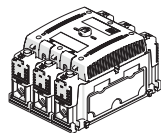

8544/1-31L

167239

We reserve the right to make alterations to the technical data, dimensions, weights, designs and products available without notice. The illustrations cannot be considered binding.