

Lighting

Emergency luminaire With LED

GRP

6409/4148-5101-162-2220-22-850011 Art. No. 272461



- The latest LED technology with a high luminous efficacy and a long service life
- Extremely high luminaire efficacy
- Variants with 90 minutes or 180 minutes emergency lighting duration available
- Luminous flux after 100,000 h still 90% of the starting luminous flux
- Optionally with DALI for controlling and monitoring the luminaire
- Automatic weekly function test and annual rated operating time test

MY R. STAHL 6409C



The emergency luminaire with Series 6409/4 LED with integrated battery can be installed in stand-by switching, continuous mode or in switchable stand-by switching. A weekly functional test and annual rated operating time test are performed automatically. The results are indicated by an LED.

Technical Data

Explosion Protection

Ex version	Yes
Application range (zones)	2, 21, 22
IECEX gas certificate	IECEX IBE 16.0047
IECEX gas explosion protection	Ex db ec IIC T4 Gc
IECEX dust certificate	IECEX IBE 16.0047
IECEX dust explosion protection	Ex tb op is IIIC T100 °C Db Ex tc IIIC T100 °C Dc
ATEX gas certificate	IBExU 16 ATEX 1233
ATEX gas explosion protection	⊕ II 3 G Ex db ec IIC T4 Gc
ATEX dust certificate	IBExU 16 ATEX 1233
ATEX dust explosion protection	⊕ II 2 D Ex tb op is IIIC T100 °C Db ⊕ II 3 D Ex tc IIIC T100 °C Dc
Certificates and approvals	ATEX IECEX
Certificates	ATEX (IBE), IECEX (IBE)
Declaration of conformity	ATEX (EUK)

Electrical Data

AC rated operational voltage	110 ... 240 V
Frequency	50 ... 60 Hz
Battery version	NiCd battery, gas-tight
Battery operating voltage	6 V
Battery capacity	7 Ah
Self-test function	With (standard)
Control gear service life	C10 ≥ 100 h, Ta ≤ 60 °C
LED service life	L90B50 ≥ 100 h

Lighting Data

Number of lamps	1
Lamp wattage	37 W

Lighting

Emergency luminaire With LED

GRP

6409/4148-5101-162-2220-22-850011 Art. No. 272461



Lighting Data

Lamp	LED
Light colour	5000 K – neutral white
Light distribution	120°x120° with diffusing glass
Luminaire efficacy	158 lm/W
Luminous flux	5770 lm
Operating time	1.5h emergency lighting operation
Emergency light output	35% – 1.5 h
Colour rendering	≥ 80

Ambient Conditions

Ambient temperature	-30 °C ... 50 °C (Through wiring max. 3x16 A) -30 °C ... 55 °C (Through wiring max. 3x10 A)
Ambient temperature	-22 °F ... 122 °F (Through wiring max. 3x16 A) -22 °F ... 131 °F (Through wiring max. 3x10 A)

Mechanical Data

Version	Standard
IP degree of protection (IEC 60598)	IP66/IP67
Enclosure material	Polyester resin, Glass fibre reinforced
Enclosure colour	Light grey (RAL 7035)
Insert nut material	Brass
Diffuser	With diffuser
Sealing material	Silicone
Silicone-free content	Contains silicone
Translucent cover material	Polycarbonate
Installed terminal strip	PE + N + L1 + L2 + L3 + L´
Max. solid connection terminals	6 mm ²
Max. finely stranded connection terminals	4 mm ²
Type of connection cable	Finely stranded Solid
Size	4
Width	183.5 mm
Height	125 mm
Length	1467 mm
Impact strength (IEC 62262)	IK10
Disconnection of the luminaire	Only battery
Weight	8.1 kg
Weight	17.86 lb

Components

Threaded plate	2x SS430 stainless steel
Ballast	LED NLE 80W 110-240V/7Ah/1.5h/
Through wiring	With 6 conductors 2.5 mm ²
Drilled holes	3 x M20
Cable glands and entries	can be ordered as an accessory
Stopping plugs	Can be ordered as accessories
Accessories	without

Lighting

Emergency luminaire With LED

GRP

6409/4148-5101-162-2220-22-850011 Art. No. 272461



Dimensional Drawings (All Dimensions in mm [inches]) – Subject to Alterations

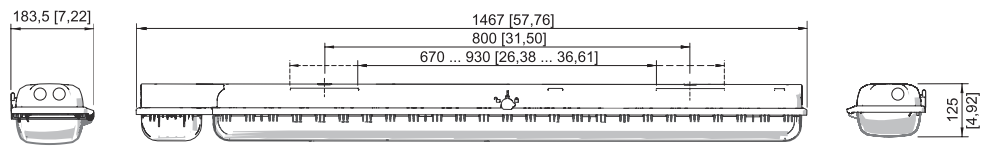
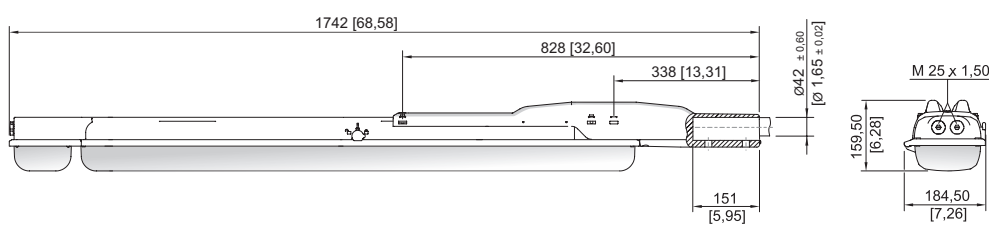
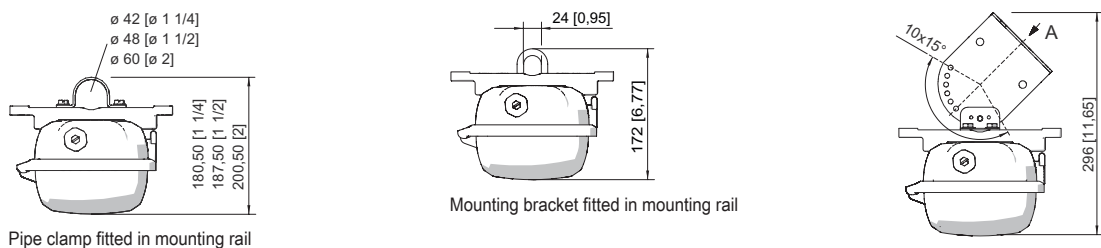
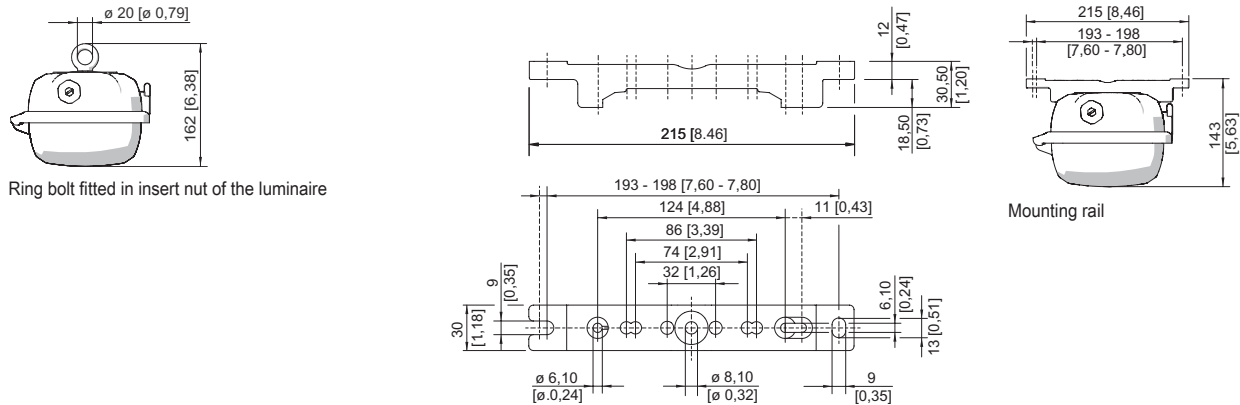

Accessories

Adapter plate for mounting EXLUX 6002 on EXLUX 6000 mounting interfaces		Art. No.
	Adapter plate for installation of EXLUX 6002 luminaires onto EXLUX 6000 interfaces	240653



Lighting

Emergency luminaire With LED

GRP

6409/4148-5101-162-2220-22-850011 Art. No. 272461

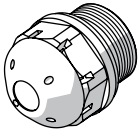
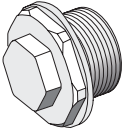
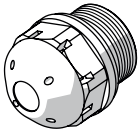
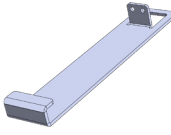

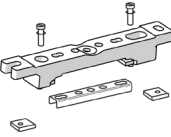
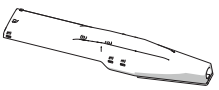
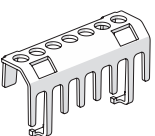
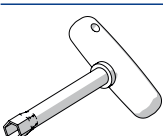
Breather		Art. No.
	Thread: M25 x 1.5 (20 pieces); without jam nut	285780
	Thread: M20 x 1.5 (1 piece); for installation in light fittings; made from stainless steel; without jam nut	323702
	Thread: M25 x 1.5 (1 piece); for installation in light fittings; made from stainless steel; without jam nut	296608
	M25 x 1.5 in order to avoid condensate formation	115738
Fall protection		Art. No.
	Accessories for mounting an arrester cable	295927
Holder for translucent cover		Art. No.
	The fall prevention system for the light fitting cover prevents the light fitting cover from falling accidentally when the light fitting is opened.	226791
Mounting rail		Art. No.
	Mounting accessories for ceiling mounting of EXLUX luminaires with V4A metal insert for reinforcement	325835
	Mounting accessories for ceiling mounting of EXLUX luminaires with V4A metal insert and captive M8 nut	329336
Pole mounting sleeve		Art. No.
	for the subsequent mounting on lights size 2 and size 4, completely with assembly parts (for pipe diameter 42 mm)	227512
Protection against accidental contact		Art. No.
	The protection against accidental contact prevents maintenance technicians and electrical installers from accidentally touching conductive parts. The degree of protection is increased to IP20 when the protection against accidental contact is used.	283153
Box spanner		Art. No.
	M8 / A/F 13; For actuating the central lock	222430



Lighting

Emergency luminaire With LED

GRP

6409/4148-5101-162-2220-22-850011 Art. No. 272461

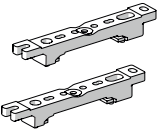
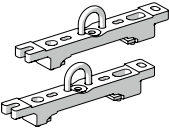
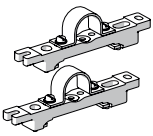

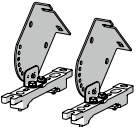
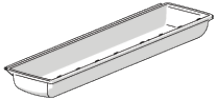
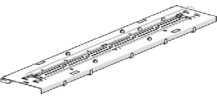
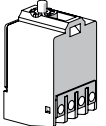
		Art. No.
Mounting rail		
	for a variable mounting distance; 1 pair	222826
Mounting bracket		
	mounting clamp mounted on a mounting rail for a variable mounting distance; 1 pair	222456
Pipe clamp		
	R 1 1/2"; with mounting rail for a variable mounting distance; material: stainless steel; 1 pair	222459
	R 1 1/4"; with mounting rail for a variable mounting distance; Material: stainless steel; 1 pair	222458
	R 2"; with mounting rail for a variable mounting distance; Material: stainless steel; 1 pair	222460
Ring bolt		
	M8, direct mounting in insert nuts; 1 pair	115736
Ceiling and wall mounting bracket		
	mounted on a mounting rail for a variable mounting distance; Material: stainless steel; Lamp can be swiveled in steps of 15°; 1 pair	222827
Spare Parts		
Cover		
	for luminaire size 4	222428
Reflector plate		
	Spare part for 6409 size 4, colour temperature 5000 K	270820
Contact element		
	8080/1-3-L 2 NC contact element	132527

Lighting

Emergency luminaire With LED

GRP

6409/4148-5101-162-2220-22-850011 Art. No. 272461



Battery set

Art. No.

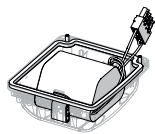

Battery cover with built-in battery. Gas-tight NiCd battery; 7 Ah / 6 V

223532

We reserve the right to make alterations to the technical data, dimensions, weights, designs and products available without notice. The illustrations cannot be considered binding.