

8602C3-009-B .. MS4 Art. No. 274101



- Pushbutton, mushroom pushbutton, mushroom stay-put button with key lock, mushroom stay-put button, twin pushbutton and illuminated pushbutton, rotary actuator, key-operated switch, potentiometer bezel and indicator lamp bezel
- One axial actuator can actuate up to four Series 8082 contact elements
- Key-operated switches and rotary switches codable at any time as "latching/spring return" or "key not removable"

MY R. STAHL 8602A



Thanks to their special technical features, the actuators from the 8602/3 series can withstand the most extreme conditions. In addition to the application option for use in ambient temperatures from -60 °C to +70 °C, the IP degree of protection, IP66, is maintained in accordance with EN 60529. It is also possible to actuate up to four contact elements from the 8082 series with a single axial actuator from the 8602/3 series.

The coding option of the key switches and rotary switches is innovative and one-of-a-kind. Integrated coding allows you to adjust the "latching/spring return" and/or "key not removable" functions at any time without additional accessories. A versatile set of accessories consisting of label holders and locking devices is available.

Technical Data

Explosion Protection

Application range (zones)	1, 2, 21, 22
IECEX gas certificate	IECEX PTB 13.0047U
IECEX gas explosion protection	Ex eb IIC Gb
IECEX dust certificate	IECEX PTB 13.0047 U
IECEX dust explosion protection	Ex tb IIIC Db
ATEX gas explosion protection	Ⓔ II 2 G Ex eb IIC Gb
ATEX dust explosion protection	Ⓔ II 2 D Ex tb IIIC Db
UL gas certificate	E182378 V4 S2
Certificate ULus	E182378 V4 S2
Marking ULus	Class I, Zone 1, AEx eb IIC Gb Zone 21, AEx tb IIIC Db
Certificate cUL	E182378V4S2
Marking cUL	Class I, Zone 1, Ex eb IIC Gb Zone 21, Ex tb IIIC Db
Inmetro gas certificate	UL-BR 14.0380U
Inmetro dust certificate	UL-BR 14.0380U
Certificates	ATEX (PTB), Brazil (ULB), Canada / USA (UL), Canada (UL), IECEX (PTB), Korea (KGS), USA (UL)

Functional Safety

SIL-capable	only with contact elements 8082, 8208/24-15
-------------	---

Ambient Conditions

Ambient temperature	-20 °C ... 60 °C
Ambient temperature	-4 °F ... +140 °F

8602C3-009-B .. MS4 Art. No. 274101

Ambient Conditions

Storage temperature	-25 °C ... 60 °C
Storage temperature	-13 °F ... +140 °F
Use at the height of	< 2000 m
Max. operating altitude	2000 m
Degree of pollution	3

Mechanical Data

Version	EM-STOP
Degree of protection (IP)	IP66
Note on degree of protection	According to IEC/EN 60529
Enclosure material	Polyamide
Silicone-free	Yes
Assembly	009
Diameter	39 mm
Service life, min.	10 ⁵ actuations
Impact strength (IEC 60079)	7 J
Impact strength (IEC 62262)	min. IK08
Colour	Yellow/red
Mounting	Thread type
Designation plate	With yellow backing plate
Seal	Standard
Closing	MS4
Packaging unit	1
Description note	Two keys enclosed.
Weight	750 g
Weight	1.65 lb

Mounting / Installation

Mounting type	Front panel mounting
Tightening torque	3 N · m
Tightening torque lbf in	26.55 lbf in

Technical Drawings – Subject to Alterations

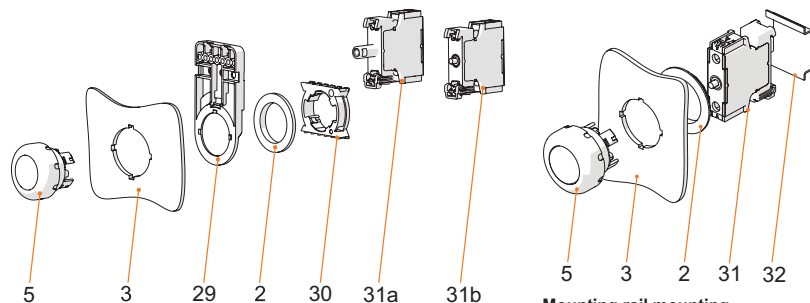

Front installation mounting with Series 8010/6 indicator lamp and Series 8082/3 contact element

- Key**
 2 = jam nut (order no. 205592)
 3 = installation wall (wall thickness max. 5 mm [0.197 inch])
 5 = actuator with seal
 29 = support for cable duct (optional) (order no. 248673)
 30 = adaptor (order no. 227038)
 31a = built-in element: LED element 8010/6
 31b = built-in element: Contact element 8082/3

Mounting rail mounting

- Key**
 2 = jam nut (order no. 205592)
 3 = installation wall (wall thickness max. 5 mm [0.197 inch])
 5 = actuator with seal
 31 = built-in element
 32 = TS35 mounting rail

Installation equipment

Mshrm sty-pt button w. key lck EMERGENCY STOP





8602C3-009-B .. MS4 Art. No. 274101

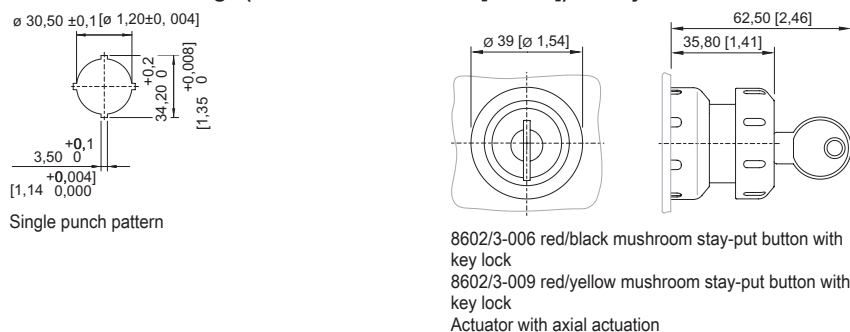

Dimensional Drawings (All Dimensions in mm [inches]) – Subject to Alterations



Accessories

Closing part		Art. No.
	8602C3-733-B for closing unused holes in cover, dia. 30.5 mm, NBR	244306
Protective collar		Art. No.
	8602C3-751 plastic/red for mushroom stay-put button with key lock/mushroom stay-put button dia. 39 BG006, BG009, BG010, BG012	257707
	8602C3-751 plastic/yellow for mushroom stay-put button with key lock/mushroom stay-put button dia. 39 BG006, BG009, BG010, BG012	257708

Spare Parts

Contact element		Art. No.
	for NC front installation	240898
	for NO contact front installation	240899
Spare key		Art. No.
	Closing MS4	272647
Insert discs for label holder		Art. No.
	One-line Plain Material: PVC Colour: White Self-adhesive	238271

Installation equipment



Mshrm sty-pt button w. key lck EMERGENCY STOP



8602C3-009-B .. MS4 Art. No. 274101

Insert discs for label holder

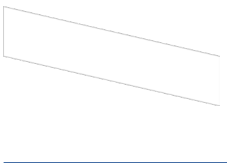
Art. No.

	Two-line Plain Material: PVC Colour: White Self-adhesive	238272
	Three-line Plain Material: PVC Colour: White Self-adhesive	238273



Label, yellow, general

Art. No.

	for Ø 39 actuator (EM-STOP)	223571
--	-----------------------------	--------

Label holder

Art. No.

	Size 1, without insert disc, 1-line label for actuators Ø 39	223566
	Size 2, without insert disc, 1- or 2-line label for actuators Ø 39	223567
	Size 3, without insert disc, 1-, 2- or 3-line label for actuators Ø 39	223568



Special key

Art. No.

	for tightening plastic locking nut	169101
--	------------------------------------	--------

Pressure plates

Art. No.

	Dia. 37 mm Three contact elements	215436
	Dia. 48.5 mm Four contact elements	215437

Installation equipment

Mshrm sty-pt button w. key lck EMERGENCY STOP



8602C3-009-B .. MS4 Art. No. 274101

Holder for front installation

Art. No.



8602/3 holder for cable duct

248673

Adaptor for front installation

Art. No.



8602/3 Front installation for indicator lamp series 8010/6 and contact element series 8082/3

227038

We reserve the right to make alterations to the technical data, dimensions, weights, designs and products available without notice. The illustrations cannot be considered binding.