

8602C3-008-B-M03-03-MS03 Art. No. 274091



- Pushbutton, mushroom pushbutton, mushroom stay-put button with key lock, mushroom stay-put button, twin pushbutton and illuminated pushbutton, rotary actuator, key-operated switch, potentiometer bezel and indicator lamp bezel
- One axial actuator can actuate up to four Series 8082 contact elements
- Key-operated switches and rotary switches codable at any time as "latching/spring return" or "key not removable"

MY R. STAHL 8602A



Thanks to their special technical features, the actuators from the 8602/3 series can withstand the most extreme conditions. In addition to the application option for use in ambient temperatures from -60 °C to +70 °C, the IP degree of protection, IP66, is maintained in accordance with EN 60529. It is also possible to actuate up to four contact elements from the 8082 series with a single axial actuator from the 8602/3 series.

The coding option of the key switches and rotary switches is innovative and one-of-a-kind. Integrated coding allows you to adjust the "latching/spring return" and/or "key not removable" functions at any time without additional accessories. A versatile set of accessories consisting of label holders and locking devices is available.

## Technical Data

### Explosion Protection

Application range (zones)	1, 2, 21, 22
IECEX gas certificate	IECEX PTB 13.0047U
IECEX gas explosion protection	Ex eb IIC Gb
IECEX dust certificate	IECEX PTB 13.0047 U
IECEX dust explosion protection	Ex tb IIIC Db
ATEX gas explosion protection	Ex II 2 G Ex eb IIC Gb
ATEX dust explosion protection	Ex II 2 D Ex tb IIIC Db
UL gas certificate	E182378 V4 S2
Certificate ULus	E182378 V4 S2
Marking ULus	Class I, Zone 1, AEx eb IIC Gb Zone 21, AEx tb IIIC Db
Certificate cUL	E182378V4S2
Marking cUL	Class I, Zone 1, Ex eb IIC Gb Zone 21, Ex tb IIIC Db
Inmetro gas certificate	UL-BR 14.0380U
Inmetro dust certificate	UL-BR 14.0380U
Certificates	ATEX (PTB), Brazil (ULB), Canada / USA (UL), Canada (UL), IECEX (PTB), Korea (KGS), USA (UL)

### Ambient Conditions

Ambient temperature	-20 °C ... 60 °C
Ambient temperature	-4 °F ... +140 °F
Storage temperature	-25 °C ... 60 °C
Storage temperature	-13 °F ... +140 °F

8602C3-008-B-M03-03-MS03 Art. No. 274091

### Ambient Conditions

Use at the height of	< 2000 m
Max. operating altitude	2000 m
Degree of pollution	3

### Mechanical Data

Degree of protection (IP)	IP66
Note on degree of protection	According to IEC/EN 60529
Enclosure material	Polyamide
Silicone-free	Yes
Number of switching positions	3
Assembly	008
Diameter	39 mm
Service life, min.	10 <sup>5</sup> actuations
Impact strength (IEC 60079)	7 J
Impact strength (IEC 62262)	min. IK08
Colour	Black
Mounting	Thread type
Seal	Standard
Closing	MS3
Packaging unit	1
Description note	Conversion to the "spring return" or "key not removable" function is possible with the installed coding elements. Additional closures on request. Two keys enclosed. Pressure plates for 1–2 and 3–4 contact elements enclosed.
Weight	50 g
Weight	0.11 lb

### Mounting / Installation

Mounting type	Front panel mounting
Tightening torque	3 N · m
Tightening torque lbf in	26.55 lbf in

### Technical Drawings – Subject to Alterations

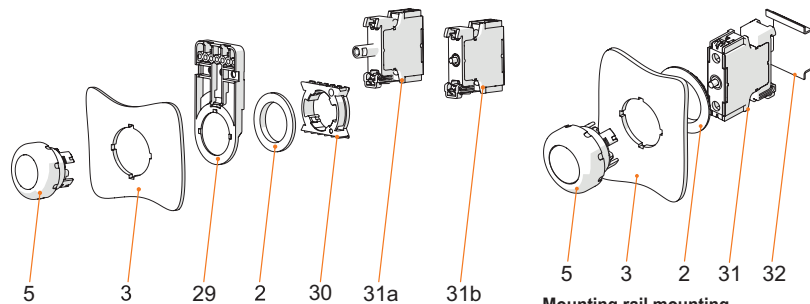

**Front installation mounting with Series 8010/6 indicator lamp and Series 8082/3 contact element**

#### Key

- 2 = jam nut (order no. 205592)
- 3 = installation wall (wall thickness max. 5 mm [0.197 inch])
- 5 = actuator with seal
- 29 = support for cable duct (optional) (order no. 248673)
- 30 = adaptor (order no. 227038)
- 31a = built-in element: LED element 8010/6
- 31b = built-in element: Contact element 8082/3

#### Mounting rail mounting

#### Key

- 2 = jam nut (order no. 205592)
- 3 = installation wall (wall thickness max. 5 mm [0.197 inch])
- 5 = actuator with seal
- 31 = built-in element
- 32 = TS35 mounting rail

8602C3-008-B-M03-03-MS03 Art. No. 274091

### Dimensional Drawings (All Dimensions in mm [inches]) – Subject to Alterations

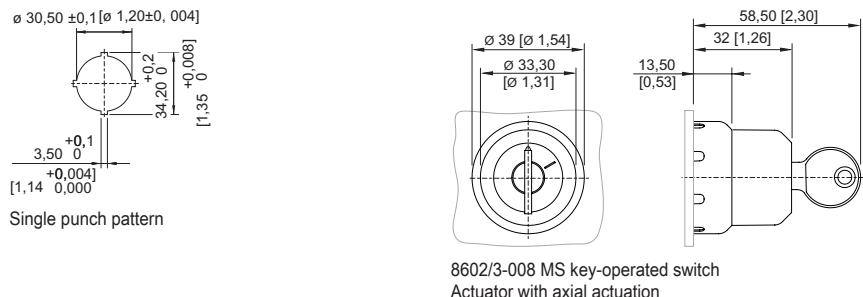

## Accessories

### Closing part



8602C3-733-B  
for closing unused holes in cover, dia. 30.5 mm, NBR

### Art. No.

244306

## Spare Parts

### Contact element



for NC front installation  
for NO contact front installation

### Art. No.

240898

240899

### Spare key



Closing MS3

### Art. No.

272646

### Insert discs for label holder



One-line  
Plain  
Material: PVC  
Colour: White  
Self-adhesive

### Art. No.

238271



Two-line  
Plain  
Material: PVC  
Colour: White  
Self-adhesive









238272



Three-line  
Plain  
Material: PVC  
Colour: White  
Self-adhesive

238273

8602C3-008-B-M03-03-MS03 Art. No. 274091

<b>Label holder</b>		<b>Art. No.</b>
	Size 1, without insert disc, 1-line label for actuators Ø 39	223566
	Size 2, without insert disc, 1- or 2-line label for actuators Ø 39	223567
	Size 3, without insert disc, 1-, 2- or 3-line label for actuators Ø 39	223568
<b>Special key</b>		<b>Art. No.</b>
	for tightening plastic locking nut	169101
<b>Pressure plates</b>		<b>Art. No.</b>
	For key-operated switch and axial rotary actuator 1 to 2 contact elements	253627
	For key-operated switch and axial rotary actuator 3 to 4 contact elements	221707
<b>Holder for front installation</b>		<b>Art. No.</b>
	8602/3 holder for cable duct	248673
<b>Adaptor for front installation</b>		<b>Art. No.</b>
	8602/3 Front installation for indicator lamp series 8010/6 and contact element series 8082/3	227038

We reserve the right to make alterations to the technical data, dimensions, weights, designs and products available without notice. The illustrations cannot be considered binding.