



- Comprehensive portfolio to cater for all characteristics
- Two-channel variants reduce the amount of space required
- Can be used up to SIL 3 (IEC/EN 61508)

07 b

MY R. STAHL 9176A



9176 series binary outputs issue binary signals for the intrinsically safe operation of Ex i solenoid valves, indicator lamps or horns. The devices do not require a separate auxiliary power supply as they are powered by the control circuit. The intrinsically safe outputs are galvanically separated from the inputs. The two-channel variants are characterised by galvanically separated channels.

	NEC® 500 CE Code Appendix J					
	Class I		Class II		Class III	
Division	1	2	1	2	1	2
Ex interface	•	•	•	•	•	•
Installation in		•				

	CE Code Section 18					
	NEC® 505			NEC® 506		
	Class I					
Zone	0	1	2	20	21	22
Ex interface	•	•	•			
Installation in			•			

	IECEX / ATEX					
	0	1	2	20	21	22
Zone						
Ex interface	•	•	•	•	•	•
Installation in			•			

Selection Table						
Number of channels	1					
Output open-circuit voltage U_a	Max. output current $I_a \text{ max}$	Internal Resistance R_i	Connection type	Product Type	Art. No.	Weight
25 V	35 mA	250 Ω	Screw terminal	9176/10-16-00s	222182	170 g
		250 Ω	Spring clamp terminal	9176/10-16-00k	222183	180 g
Number of channels	2					
Output open-circuit voltage U_a	Max. output current $I_a \text{ max}$	Internal Resistance R_i	Connection type	Product Type	Art. No.	Weight
25 V	29 mA / 58 mA*	320 Ω /parallel: 160 Ω *	Screw terminal	9176/20-15-00s	222180	185 g
		320 Ω /parallel: 160 Ω *	Spring clamp terminal	9176/20-15-00k	222181	180 g
	35 mA / 70 mA*	250 Ω /parallel: 125 Ω *	Screw terminal	9176/20-16-00s	222184 ▲	185 g
		250 Ω /parallel: 125 Ω *	Spring clamp terminal	9176/20-16-00k	222185	180 g
	43 mA / 86 mA*	460 Ω /230 Ω *	Screw terminal	9176/20-17-00s	222188	185 g
		460 Ω /230 Ω *	Spring clamp terminal	9176/20-17-00k	222189	180 g

* Parallel connection of the outputs possible; thus, doubling the output current and halves the internal resistance.

Technical Data			
Variant	9176/0-15-00s	9176/0-16-00s	9176/0-17-00s
Explosion Protection			
FMus certificate	FM16US0122X	FM16US0122X	FM16US0122X
cFM certificate	FM16CA0067X	FM16CA0067X	FM16CA0067X

Technical Data			
Variant	9176/0-15-00s	9176/0-16-00s	9176/0-17-00s
Explosion Protection			
Marking cFMus	Class I, Div. 2, Groups A,B,C,D; Class I, Zone 2, Group IIC AIS Class I,II,III, Div. 1, Groups A,B,C,D,E,F,G; Class I, Zone 0, [AEx ia]/[Ex ia] IIC T4 Mounting vert. at Ta = 70°C , or horizontal Ta = 60°C See Doc. 91 766 01 31 1	Class I, Div. 2, Groups A,B,C,D; Class I, Zone 2, Group IIC AIS Class I,II,III, Div. 1, Groups A,B,C,D,E,F,G; Class I, Zone 0, [AEx ia]/[Ex ia] IIC T4 Mounting vert. at Ta = 70°C , or horizontal Ta = 60°C See Doc. 91 766 01 31 1	Class I, Div. 2, Groups A,B,C,D; Class I, Zone 2, Group IIC AIS Class I,II,III, Div. 1, Groups A,B,C,D,E,F,G; Class I, Zone 0, [AEx ia]/[Ex ia] IIC T4 Mounting vert. at Ta = 70°C , or horizontal Ta = 60°C See Doc. 91 766 01 31 1
IECEX gas explosion protection	Ex nA [ia Ga] IIC T4 Gc	Ex nA [ia Ga] IIC T4 Gc	Ex nA [ia Ga] IIC T4 Gc
IECEX dust explosion protection	[Ex ia Da] IIIC	[Ex ia Da] IIIC	[Ex ia Da] IIIC
Certificates	ATEX (BVS), Brazil (ULB), Canada (FM), China (NEPSI), IECEX (BVS), Korea (KTL), SIL (exida), USA (FM)	ATEX (BVS), Brazil (ULB), Canada (FM), China (NEPSI), IECEX (BVS), Korea (KTL), SIL (exida), USA (FM)	ATEX (BVS), Brazil (ULB), Canada (FM), IECEX (BVS), Korea (KTL), SIL (exida), USA (FM)
Ship approval	CCS, EU RO MR (DNV)	CCS, EU RO MR (DNV)	CCS, EU RO MR (DNV)
Safety Data			
Max. voltage U_0/V_{oc}	27.6 V	27.6 V	27.6 V
Max. current I_0 (Ex ia)	86.5 mA	110 mA	60 mA
Max. current I_0 (Ex ib)	44 mA	50 mA	
Max. power P_0	596 mW	760 mW	415 mW
Safety-related max. voltage	253 V	253 V	253 V
Functional Safety			
SIL	3	3	3
Auxiliary Power			
Auxiliary power	without	without	without
Input			
Input voltage for ON	18 – 31.2 V	18 – 31.2 V	18 – 31.2 V
Input voltage for OFF	0 – 5 V	0 – 5 V	0 – 5 V
Output			
Output open-circuit voltage U_o	25 V	25 V	25 V
Max. output current $I_{o,max}$	29 mA /58 mA*	35 mA /70 mA*	43 mA /86 mA*
Internal Resistance R_i	320 Ω/parallel: 160 Ω*	250 Ω/parallel: 125 Ω*	460 Ω/230 Ω*
Output residual ripple	< 100 mV	< 100 mV	< 100 mV
Output switching frequency	≤ 10 Hz	≤ 10 Hz	≤ 10 Hz
Switching delay ON/OFF	≤ 50 ms	≤ 50 ms	≤ 50 ms
Notes	* Parallel connection of the outputs possible; thus, doubling the output current and halves the internal resistance.		
Ambient Conditions			
Ambient temperature °F	-4 °F ... +158 °F (Single device) -4 °F ... +140 °F (Group assembly)	-4 °F ... +158 °F (Single device) -4 °F ... +140 °F (Group assembly)	-4 °F ... +158 °F (Single device) -4 °F ... +140 °F (Group assembly)
Ambient temperature °C	-20 °C ... +70 °C (Single device) -20 °C ... +60 °C (Group assembly)	-20 °C ... +70 °C (Single device) -20 °C ... +60 °C (Group assembly)	-20 °C ... +70 °C (Single device) -20 °C ... +60 °C (Group assembly)
Storage temperature °F	-40 °F ... +176 °F	-40 °F ... +176 °F	-40 °F ... +176 °F
Storage temperature °C	-40 °C ... +80 °C	-40 °C ... +80 °C	-40 °C ... +80 °C
Mounting / Installation			
Mounting type	DIN rail NS35/15, NS35/7.5	DIN rail NS35/15, NS35/7.5	DIN rail NS35/15, NS35/7.5

Technical Drawings – Subject to Alterations

07 b

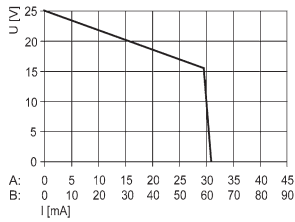

9176/0-15-00 output characteristic

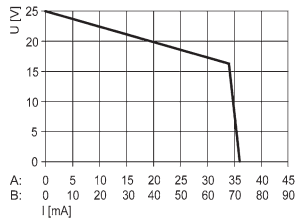

9175/0-16-11; 9176/0-16-00 output characteristic

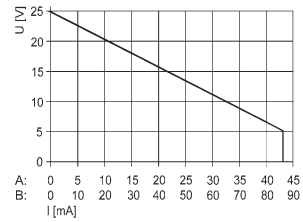

9176/0-17-00 output characteristic

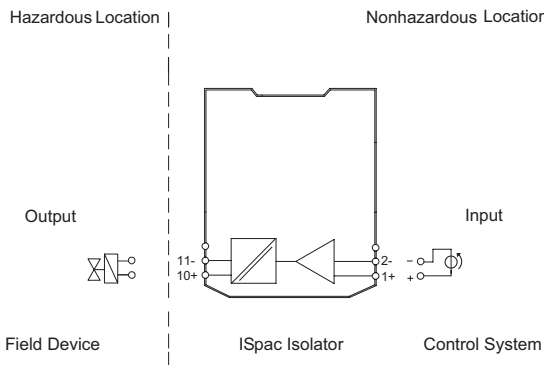

Connection diagram 9176/10-...-

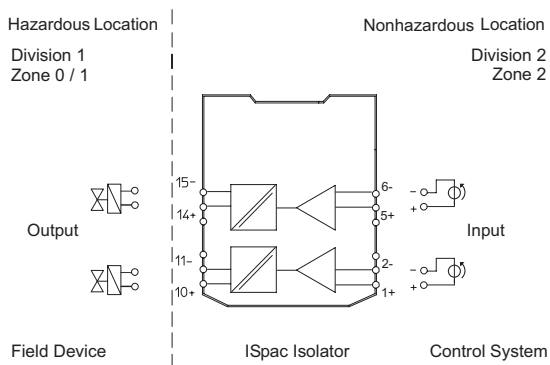

Connection diagram 9176/20-...-

Accessories

Figure	Description	Art. No.	Weight
Transparent cover			
	For 91xx ISpac modules Yellow, transparent Clear identification of the device for SIL applications. (Packaging unit: 10 pieces)	200914	20 g

Spare Parts

Figure	Description	Art. No.	Weight
Screw terminal			
	3-pole plug, screw connector thread: M3 stripping length: 7 mm color: green	112817	5 g
	3-pole plug, screw connector thread: M3 stripping length: 7 mm color: black	112816	4 g
	3-pole plug, screw connector thread: M3 stripping length: 7 mm color: blue	112818	5 g

Spare Parts			
Figure	Description	Art. No.	Weight
Screw terminal with test tap			
	3-pole plug with test tap, screw connector thread: M3 stripping length: 7 mm colour: black	113005	1 g
	3-pole plug with test tap, screw connector thread: M3 stripping length: 7 mm colour: blue	113004	1 g
Spring clamp terminal			
	3-pole plug with test tap, spring clamp connection stripping length: 10 mm color: green	112825	5 g
	3-pole plug with test tap, spring clamp connection stripping length: 10 mm color: black	112824	5 g
	3-pole plug with test tap, spring clamp connection stripping length: 10 mm color: blue	112826	5 g

Dimensional Drawings (All Dimensions in mm [inches]) – Subject to Alterations

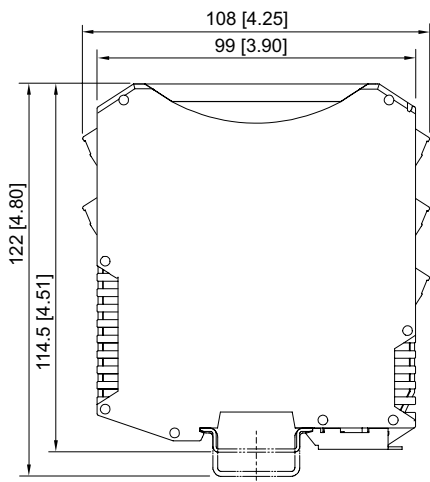

ISpac Series 9143, 9146, 9147, 9160, 9162, 9163, 9165, 9167, 9170, 9172, 9175, 9176, 9180, 9182, 9193, ISbus Series 9412 with screw terminal

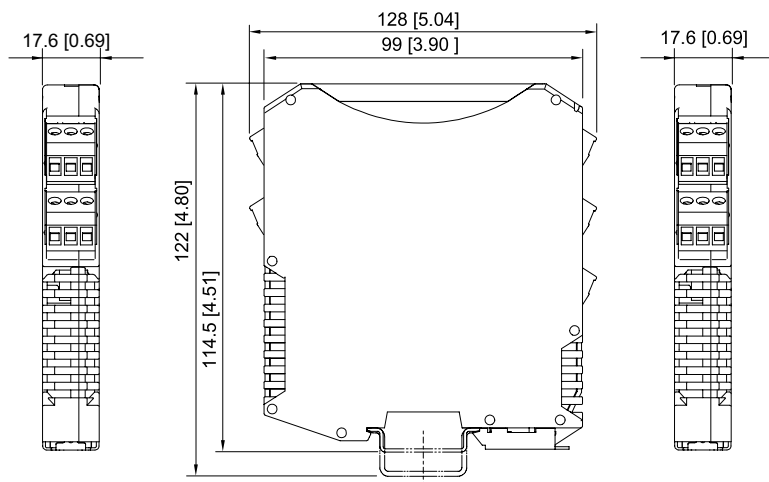

ISpac Series 9146, 9147, 9160, 9162, 9163, 9165, 9167, 9170, 9172, 9175, 9176, 9180, 9182, 9193, Fieldbus Power Supply Series 9412 with spring clamp terminal