

Load & Motor Disconnect Switches



Load disconnect switch

0 A, non-fused

7146/5-V11-D32-00-0000-0 Art. No. 286746



- 3-pole horsepower (hp) rated switch
- Suitable for voltages up to 600 V AC / 240 V DC - restrictions may apply
- Pad lockable robust rotary handle
- Lightweight construction
- Fiberglass reinforced polyester (FRP)
- Suitable for low ambient temperatures
- Enclosure type 3, 4, 4X, IP66
- No conduit seals required
- Class I, Div. 2 / AEx Zone 2

MY R. STAHL 7146A



Our switches are specifically engineered for hazardous locations and harsh environments with a corrosion resistant enclosure and wide temperature range. Ideal for close proximity installation of field equipment such as control panels, motors, skids or machinery. Whether the requirement is for disconnect switches to completely de-energize for service or maintenance tasks, or transfer switches to ensure continuous power supply to essential equipment, our solutions offer unmatched reliability. With our standard solutions, entries are not pre-installed, providing users with the flexibility to customized their own entries based on size, location and type. Built to withstand demanding conditions while ensuring safety and ease of use in various applications.

Technical Data

Explosion Protection

Area of application	Canada USA
FMus certificate	FM18US0275X
cFM certificate	FM18CA0132X
Marking FMus	Class I, Div. 2, Groups A,B,C,D; T4; Enclosure Type 3, 4, 4X
Marking cFM	Class I, Div. 2, Groups A,B,C,D; T4; Enclosure Type 3, 4, 4X
Marking cFM note	Zone 2 IIC per Canadian Electrical Code Table 18
Certificates	Canada (FM), USA (FM)

Electrical Data

Rated operational voltage AC	600 V
Rated operational voltage DC 1-pole	60 V
Rated operational voltage DC 2-pole	125 V
Rated operational voltage DC 3-pole	240 V
Rated operational current	100 A
Frequency range	50 – 60 Hz
Horsepower rating	75 hp
Horsepower rating note	Horsepower rating (hp) in relation to rated operating voltage 480 V AC
Auxiliary contact NC	without
Auxiliary contact NO	without
Short circuit protection (sym RMS)	25 kA
Additional short-circuit protection	Additional fuse necessary
Short-circuit protection note	Required back-up fuse in the electrical circuit

Load & Motor Disconnect Switches



Load disconnect switch

0 A, non-fused

7146/5-V11-D32-00-0000-0 Art. No. 286746

Auxiliary Power

Nominal voltage V_{nom} 480 V AC

Ambient Conditions

Ambient temperature °C -50°C ... +55°C

Ambient temperature °F -58°F ... +131°F

Mechanical Data

Degree of protection (IP) IP66

Enclosure type (UL50 & UL50E) 3, 4, 4X

Enclosure material Polyester, Fiberglass Reinforced Polyester (FRP)

Additional terminal without

Connection cross section, stranded min. 10 AWG

Connection cross section, stranded max. 300 kcmil

Construction type Standard

Width 340.5 mm

Width, inches 13.41 in

Height 681.5 mm

Height in inches 26.83 in

Depth 243 mm

Depth in inches 9.57 in

Service life, min. 10^5 operating cycles

Handle color Black

Protective collar color Black

Seal Silicone, foamed

Lockable in OFF – 3 positions

Detailed number of poles 3-pole

Weight 18.1 kg

Components

Entries without

Technical Drawings – Subject to Alterations

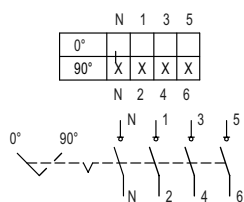

Switching arrangement 8544/1-4 and 8549/1-4

Load & Motor Disconnect Switches



Load disconnect switch

0 A, non-fused

7146/5-V11-D32-00-0000-0 Art. No. 286746

Dimensional Drawings (All Dimensions in mm [inches]) – Subject to Alterations

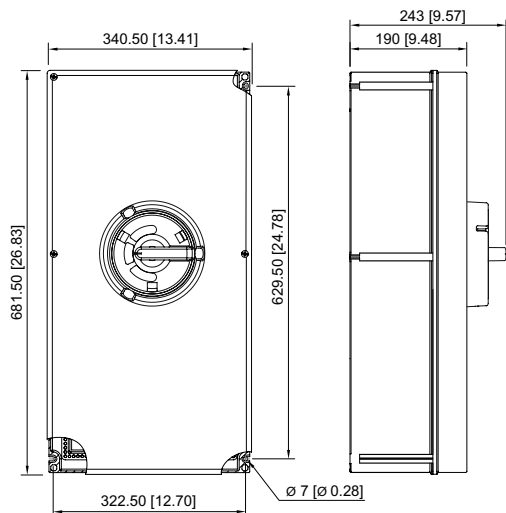

- 7146/5-V11-D32-00-0000-0
- 7146/5-V11-D08-00-0000-0
- 7146/5-V11-D09-00-0000-0
- 7146/5-V11-D32-AA-0000-0
- 7146/5-V11-D08-AA-0000-0
- 8146/5-V11-D32-00-0000-0
- 8146/5-V11-D08-00-0000-0
- 8146/5-V11-D09-00-0000-0

Load & Motor Disconnect Switches



Load disconnect switch

0 A, non-fused

7146/5-V11-D32-00-0000-0 Art. No. 286746

Accessories

Ex e cable glands for MC, MC-HL, combined and "TECK" armouring Series TMC

	Art. No.
 <p>Thread size: NPT1/2 Clamping range: 8.7 ... 12.7 mm Clamping range inch: 0.34 ... 0.5 in Nickel-plated brass</p>	254316
<p>Thread size: NPT1/2 Clamping range: 13 ... 17 mm Clamping range inch: 0.51 ... 0.67 in Nickel-plated brass</p>	254317
<p>Thread size: NPT3/4 Clamping range: 15 ... 23.3 mm Clamping range inch: 0.59 ... 0.92 in Nickel-plated brass</p>	106090
<p>Thread size: NPT1 Clamping range: 19.8 ... 29.2 mm Clamping range inch: 0.78 ... 1.15 in Nickel-plated brass</p>	106091
<p>Thread size: NPT1-1/4 Clamping range: 27.5 ... 35.2 mm Clamping range inch: 1.08 ... 1.39 in Nickel-plated brass</p>	254320
<p>Thread size: NPT1-1/2 Clamping range: 33.5 ... 41.1 mm Clamping range inch: 1.32 ... 1.62 in Nickel-plated brass</p>	254321
<p>Thread size: NPT2 Clamping range: 45 ... 53 mm Clamping range inch: 1.77 ... 2.09 in Nickel-plated brass</p>	254323
<p>Thread size: NPT2-1/2 Clamping range: 52.1 ... 58.9 mm Clamping range inch: 2.05 ... 2.32 in Nickel-plated brass</p>	254324
<p>Thread size: NPT2-1/2 Clamping range: 57.1 ... 64.6 mm Clamping range inch: 2.25 ... 2.54 in Nickel-plated brass</p>	254325
<p>Thread size: NPT3 Clamping range: 64.6 ... 75.3 mm Clamping range inch: 2.54 ... 2.96 in Nickel-plated brass</p>	254326
<p>Thread size: NPT3-1/2 Clamping range: 74 ... 88.5 mm Clamping range inch: 2.91 ... 3.48 in Nickel-plated brass</p>	254327

Auxiliary contact

	Art. No.
 <p>Note: The auxiliary contacts can only be retrofitted for 40 A, 63 A and 80 A versions. For all other versions, the auxiliary contact must be ordered separately when placing the order. Ret-rofitting is not possible for this.</p>	

Load & Motor Disconnect Switches



Load disconnect switch

0 A, non-fused

7146/5-V11-D32-00-0000-0 Art. No. 286746

Spare Parts

Load/motor switch / Load disconnect switch

Art. No.



100 A, 125 A and 150 A
Number of poles: 3 P
Type: 8549/1-32
Load/motor switch / Load disconnect switch

171181

We reserve the right to make alterations to the technical data, dimensions, weights, designs and products available without notice. The illustrations cannot be considered binding.