

## Control Devices

Control device system ConSig 8040 series

Pushbutton

8040/12E8X-01L12SA05-01L09SA05 Art. No. 287013

STAHL

ConSig



- Quad certified control stations (NEC®, CE Code, ATEX, IECEX)
- Lightweight enclosure made from fiberglass reinforced polyester (FRP), excellent for corrosive atmospheres
- Offers a variety of pushbuttons, illuminated pushbuttons, control switches and LEDs for different configurations
- Customizable control stations available upon request with different entry, contact options and additional certifications

MY R. STAHL 8040E



R. STAHL's series 8040 NEC®/ CE Code control stations utilize explosion-protected components with non-metallic enclosures for the ultimate flexibility, safety and durability in hazardous and hostile locations. Choose from one of the standard versions or contact us for a customized solution.

### Technical Data

#### Explosion Protection

Scope of validity	European Union (ATEX) Canada IECEX USA
Application range (Zones)	1 2 21 22
IECEX gas certificate	IECEX PTB 06.0025
IECEX gas explosion protection	Ex db eb IIC T6 Gb
IECEX dust certificate	IECEX PTB 06.0025
IECEX dust explosion protection	Ex tb IIIC T80 °C Db
ATEX gas certificate	PTB 01 ATEX 1105
ATEX gas explosion protection	⊕ II 2 G Ex db eb IIC T6 Gb
ATEX dust certificate	PTB 01 ATEX 1105
ATEX dust explosion protection	⊕ II 2 D Ex tb IIIC T80 °C Db
Certificate ULus	E182378V1S5
Marking ULus	Class I, Div. 2, Groups A,B,C,D Class II, III, Div. 2, F,G Class I, Zone 1, AEx db eb IIC T6 Enclosure Type 3, 4, 4X
Certificate cUL	E182378V1S5
Marking cUL	Ex db eb IIC T6 Class I, Div. 2, Groups A,B,C,D Class II, III, Div. 2, F, G Enclosure Type 3, 4, 4X
Certificates	ATEX (PTB), Brazil (ULB), Canada (UL), China (NEPSI), IECEX (PTB), India (PESO), Korea (KGS), Taiwan (ITRI), USA (UL)
Ship approval	DNVGL

# Control Devices

Control device system ConSig 8040 series

Pushbutton

8040/12E8X-01L12SA05-01L09SA05 Art. No. 287013



## Explosion Protection

Notes	Product label for standard configurations as NEC®, CE Code, ATEX, and IECEx. For additional certifications, contact factory.
-------	--

## Electrical Data

Rated operational voltage AC	550 V
Rated operational current	10 A

## Ambient Conditions

Ambient temperature °C	-50 °C ... +40 °C
Ambient temperature °F	-58 °F ... +104 °F

## Mechanical Data

Degree of protection (IP)	IP66
Degree of protection IP (IEC 60529)	IP66
Enclosure Type (UL50 & UL50E)	3, 4, 4X
Enclosure material	Polyester resin, Fiberglass reinforced
Enclosure color	Dark grey
Silicone-free	No
AWG clamping range	14 AWG
Connection cross-section max.	2.5 mm <sup>2</sup>
Solid connection cross section	0.32 – 2.5 mm <sup>2</sup>
Connection cross-section AWG single stranded	22 AWG to 14 AWG
Finely stranded connection cross section	0.32 – 2.5 mm <sup>2</sup>
Finely stranded connection cross-section AWG	22 AWG - 14 AWG
Cover fixing type	With captive screws, M4 stainless steel screws
Width	80 mm
Width, inches	3.15 in
Height	139 mm
Height, inches	5.47 in
Depth	72 mm
Depth, inches	2.76 in
Seal	Silicone, foamed
Weight	906 g
Weight	2 lb

## Mounting / Installation

Tightening torque of cover screw 1	1.4 Nm
Tightening torque of cover screw 1 lbf in	12.4 lbf in

## Components

Installation position top	Pushbutton, Green – "START", With silicone seal
Built-in element top	Contact element NC/NO
Installation position bottom	Pushbutton, Red - "STOP", With silicone seal
Built-in element bottom	Contact element NC/NO
Flange and plates	Metal plate, bottom
Entry type	CMP
Entry 1 type	Metal adapter
Entry 1	NPT 3/4"

# Control Devices

Control device system ConSig 8040 series

Pushbutton

8040/12E8X-01L12SA05-01L09SA05 Art. No. 287013



## Components

Metal entry possible 1	Yes
------------------------	-----

## Technical Drawings – Subject to Alterations

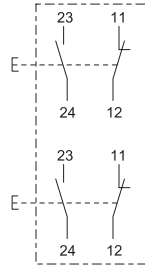
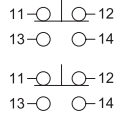

## Dimensional Drawings (All Dimensions in mm [inches]) – Subject to Alterations

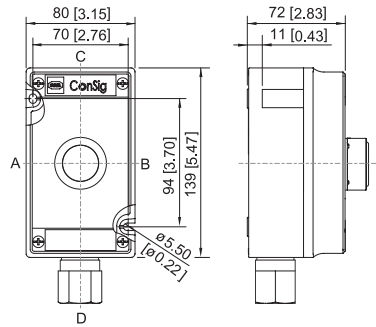

ConSig 8040/12E



## Accessories

### Pushbutton

		Art. No.
	Ø 39 mm Black Designation plate: Black, blank disc without text Silicone-free: No	223692

## Spare Parts

### Label holder

		Art. No.
	Size 1, without insert disc, 1-line label for actuators Ø 39	223566
	Size 2, without insert disc, 1- or 2-line label for actuators Ø 39	223567
	Size 3, without insert disc, 1-, 2- or 3-line label for actuators Ø 39	223568

## Control Devices

Control device system ConSig 8040 series

Pushbutton

8040/12E8X-01L12SA05-01L09SA05 Art. No. 287013

STAHL

### Label set for BG001, BG023

Art. No.



Button label set contains 8 labels  
5x blank label without text in the colors red, green, white, blue, yellow  
1x label in the color red, text: STOP  
1x label in the color green, text: START  
1x label in the color blue, text: RESET

321791

### Locking devices

Art. No.



8602C3-753 for not actuated pushbutton  
BG001

244870



8602C3-754 for actuated pushbutton  
BG001

244871



8602C3-755 for not actuated pushbutton  
BG001

244872

### Special key

Art. No.



for tightening plastic locking nut

169101

We reserve the right to make alterations to the technical data, dimensions, weights, designs and products available without notice. The illustrations cannot be considered binding.