

Isolator Barriers

Binary output

Ex i field circuit

9175/20-12-11s Art. No. 160404



- Comprehensive portfolio to cater for all characteristics
- Two-channel variants reduce the amount of space required
- Can be used up to SIL 3 (IEC/EN 61508)
- For interface solenoid valves and LEDs

MY R. STAHL 9175A



9175 series binary outputs issue binary signals via one or two channels for the intrinsically safe operation of Ex i solenoid valves, indicator lamps or horns. The devices feature three-way galvanic separation. A wire-breakage and short-circuit monitoring system, which can be disconnected, directly monitors the state of the field circuit.

Technical Data

Explosion Protection

Application range (Zones)	2
Ex interface zone	0 1 2 20 21 22
IECEX gas certificate	IECEX BVS 10.0050 X
IECEX gas explosion protection	Ex nA nC [ja Ga] IIC T4 Gc
IECEX dust certificate	IECEX BVS 10.0050 X
IECEX dust explosion protection	[Ex ia Da] IIIC
ATEX gas certificate	DMT 03 ATEX E 043 X
ATEX gas explosion protection	⊕ II 3 (1) G Ex nA nC [ja Ga] IIC T4 Gc
ATEX dust certificate	DMT 03 ATEX E 043 X
ATEX dust explosion protection	⊕ II (1) D [Ex ia Da] IIIC
FMus certificate	FM16US0122X
cFM certificate	FM16CA0067X
Marking cFMus	Class I, Div. 2, Groups A,B,C,D; Class I, Zone 2, Group IIC AIS Class I,II,III, Div. 1, Groups A,B,C,D,E,F,G; Class I, Zone 0, [AEx ia]/[Ex ia] IIC T4 Mounting vert. at Ta = 70°C , or horizontal Ta = 60°C See Doc. 91 756 01 31 1
cULus certificate	E81680V1S7
Marking cULus	prov. intr. safe circ. f.u.in Class I,II,III, Groups A,B,C,D,E,F,G; See Doc. 91 756 01 31 3
Certificates	ATEX (BVS), Brazil (ULB), Canada (FM), China (NEPSI), IECEX (BVS), Korea (KTL), SIL (exida), USA (FM), USA (UL)
Ship approval	CCS, EU RO MR (DNV)

Isolator Barriers

Binary output

Ex i field circuit

9175/20-12-11s Art. No. 160404



Explosion Protection

Declaration of Conformity ATEX (EUK), China (CCC)

Safety Data

Max. voltage U_o/V_{oc}	11.3 V
Max. current I_o (Ex ia)	75 mA
Max. power P_o	210 mW
Max. permissible external capacitance C_o/C_a for IIC	1.79 μ F
Max. permissible external capacitance C_o/C_a for IIB	12.1 μ F
Max. permissible external inductance L_o/L_a for IIC	6.3 mH
Max. permissible external inductance L_o/L_a for IIB	25 mH
Internal capacitance	1.1 nF
Internal inductance	Negligible
Safety-related max. voltage	253 V
Intrinsically safe limiting values inductance L_o /capacitance C_o	Max. connectable inductance L_o /capacitance C_o 2 parallel channels
IIC	L_o [mH] 1,5 mH C_o [μ F] 1.790 μ F
IIB	L_o [mH] 6 mH C_o [μ F] 12.100 μ F
IIIC	L_o [mH] 6.000 mH C_o [μ F] 12.100 μ F

Functional Safety

SIL	3
HFT	0
SFF	93%
Lambda SU	210 FIT
Lambda DD	0 FIT
Lambda DU	14 FIT
PFD_{avg} at T_{proof} 1 year	6,50E-05
PFD_{avg} at T_{proof} 2 years	1,24E-04
PFD_{avg} at T_{proof} 5 years	3,01E-04

Electrical Data

Number of channels	2
LFD relay	Yes
Short circuit error detec. OFF	40 ... 60 $\Omega \pm 3 \Omega$ /10 K

Auxiliary Power

Auxiliary power	24 V DC
Auxiliary power voltage range	18 to 31.2 V
Voltage range residual ripple	$\leq 3,6 V_{SS}$
Nominal current	140 mA
Power consumption	3.4 W
Max. power dissipation	2.4 W
Polarity reversal protection	Yes

Isolator Barriers

Binary output

Ex i field circuit

9175/20-12-11s Art. No. 160404



Auxiliary Power

Undervoltage monitoring	Yes
Operation indication	Green "PWR" LED

Galvanic Isolation

Test voltage as per standard	IEC EN 60079-11
Galvanic separation Ex i output to input	1,5 kV AC
Galvanic separation Ex i output to HE	1,5 kV AC
Galvanic separation Ex i output to FMC	1,5 kV AC
Ex i input to Ex i input	N/A
Test voltage as per standard	EN 50178
Fault message contact to auxiliary power	350 V AC
Input to auxiliary power	350 V AC
Input to input	350 V AC
Fault message contact to input	350 V AC

Input

Input	In accordance with EN 61131-2
Input voltage for ON	15 – 31.2 V
Input voltage for OFF	0 – 5 V
Control current	< 5 mA

Output

Output open-circuit voltage U_a	10 V
Max. output current $I_{a,max}$	60 mA
Max. output current I_a note	Parallel channels: 120 mA
Internal resistance R_i note	150 Ω /parallel: 75 Ω
Output residual ripple	< 50 mV
Output switching frequency	\leq 200 Hz
Switching delay ON/OFF	\leq 1 ms
Switching delay OFF/ON	\leq 1 ms
Switching state indication	Yellow "OUT" LED
Fault message contact switching capacity	30 V / 100 mA
LF switch user adjustment	Activated/deactivated
Indication of line fault	Red "LF" LED
Wire breakage error detection	> 7 k Ω / > 3.5 k Ω
Short circuit error detection	40 to 60 ohm \pm 3 ohm/10 K
Wire breakage error detection OFF	> 7 k Ω / > 3,5 k Ω
KS parallel error detection	20 to 30 ohm \pm 3 ohm/10 K
Line fault and loss of power signalization	Contact (30 V / 100 mA) closed to ground in case of fault pac-Bus, floating contact (30 V / 100 mA)
Test current	2.7 mA (at 100-ohm load)
Parallel channels test current	0.68 mA (at 7-k Ω load)
Note	You can find a list of connectible Ex i solenoid valves on our homepage www.r-stahl.com (WebCode 9175A)

Isolator Barriers

Binary output

Ex i field circuit

9175/20-12-11s Art. No. 160404



9175/0-12-11, 9176/0-12-00 output characteristic

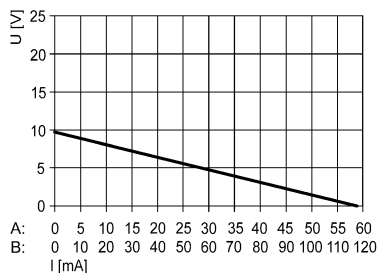

At U_N: -20 to +60 °C

X axis (I [mA])

A: Characteristic curve for each channel

B: Characteristic curve for channel 1, parallel channel 2 (only types 9175/20-...-...)

Ambient Conditions

Ambient temperature °C	-20 °C ... +70 °C (Single device) -20 °C ... +60 °C (Group assembly)
Ambient temperature °F	-4 °F ... +158 °F (Single device) -4 °F ... +140 °F (Group assembly)
Storage temperature °C	-40 °C ... +80 °C
Storage temperature °F	-40 °F ... +176 °F
Max. relative humidity	95%
Use at the height of	< 2000 m
Electromagnetic compatibility	Tested to the following standards and regulations: EN 61326-1 For use in industrial areas; NAMUR NE 21

Mechanical Data

Degree of protection (IP)	IP30
Degree of protection (IP) terminals	IP20
Fire resistance (UL 94)	V0
Enclosure material	Polyamide
Grid dimension	17.6 mm
Width	17.6 mm
Width, inches	0.69 in
Height	114.5 mm
Height, inches	4.51 in
Length	108 mm
Length, inches	4.25 in
Weight	190 g
Weight	0.42 lb

Mounting / Installation

Mounting type	DIN rail NS35/15, NS35/7.5
Mounting orientation	Horizontal Vertical
Connection type	Screw terminal
Min. rigid conductor cross section	0.2 mm ²
Max. rigid conductor cross section	2.5 mm ²
Min. flex conductor cross section	0.2 mm ²
Max. flex conductor cross section	2.5 mm ²
Connection cross-section AWG	24 – 14

Isolator Barriers

Binary output

Ex i field circuit

9175/20-12-11s Art. No. 160404



Technical Drawings – Subject to Alterations

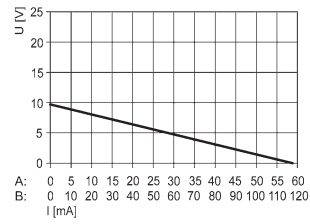

9175/0-12-11, 9176/0-12-00 output characteristic

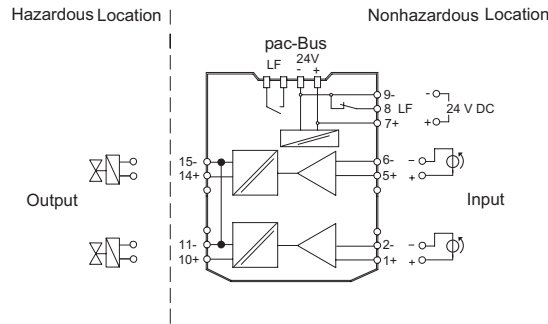

Connection Diagram 9175/20-1x-11

Dimensional Drawings (All Dimensions in mm [inches]) – Subject to Alterations

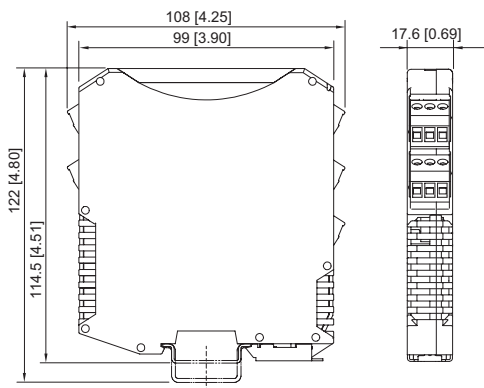

ISpac Series 9143, 9146, 9147, 9160, 9162, 9163, 9165, 9167, 9170, 9172, 9175, 9176, 9180, 9182, 9193, ISbus Series 9412 with screw terminal

Accessories

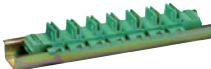
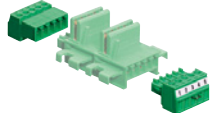
Transparent cover		Art. No.
	For 91xx ISpac modules Yellow, transparent Clear identification of the device for SIL applications. (Packaging unit: 10 pieces)	200914
pac-Bus		Art. No.
	Wiring auxiliary power and collective error message	160731
Terminal set for pac-Bus		Art. No.
	For the supply of 24 V DC auxiliary power via terminals (alternative to using the supply module 9193/21-11-11), with jumper for error message chain for ISpac module 91xx	160730

Spare Parts

Screw terminal	Art. No.
----------------	----------



Isolator Barriers

Binary output

Ex i field circuit



9175/20-12-11s Art. No. 160404



	3-pole plug, screw connector thread: M3 stripping length: 7 mm color: green	112817
	3-pole plug, screw connector thread: M3 stripping length: 7 mm color: black	112816
	3-pole plug, screw connector thread: M3 stripping length: 7 mm color: blue	112818



Screw terminal with test tap

Art. No.

	3-pole plug with test tap, screw connector thread: M3 stripping length: 7 mm colour: black	113005
	3-pole plug with test tap, screw connector thread: M3 stripping length: 7 mm colour: blue	113004

Spring clamp terminal

Art. No.

	3-pole plug with test tap, spring clamp connection stripping length: 10 mm color: green	112825
	3-pole plug with test tap, spring clamp connection stripping length: 10 mm color: black	112824
	3-pole plug with test tap, spring clamp connection stripping length: 10 mm color: blue	112826

We reserve the right to make alterations to the technical data, dimensions, weights, designs and products available without notice. The illustrations cannot be considered binding.