

Isolator Barriers

Temperature transmitter

Ex i field circuit ISpac

9182/20-51-11k Art. No. 160544



- Ex i temperature transmitter, can be configured for virtually any common sensor type
- Broad range, including variants with signal conversion and trip amplifier function
- Variants for SIL 2 applications available

MY R. STAHL 9182A



9182 series Ex i temperature transmitters for field circuits can be used to connect temperature sensors and potentiometers. They are easy to configure for virtually any sensor type by means of software or a DIP switch. These sensor types include Pt100 sensors, thermocouples and potentiometers. Variants with a trip amplifier function allow the input signal to be analysed using two independent contacts.

Technical Data

Explosion Protection	
Application range (zones)	2
Ex interface zone	0, 1, 2, 20, 21, 22
IECEX gas certificate	IECEX BVS 09.0046 X
IECEX gas explosion protection	Ex ec nC [ia Ga] IIC T4 Gc
IECEX dust certificate	IECEX BVS 09.0046 X
IECEX dust explosion protection	[Ex ia Da] IIIC
ATEX gas certificate	DMT 02 ATEX E 243 X
ATEX gas explosion protection	⊕ II 3 (1) G Ex ec nC [ia Ga] IIC T4 Gc
ATEX dust certificate	DMT 02 ATEX E 243 X
ATEX dust explosion protection	⊕ II (1) D [Ex ia Da] IIIC
FMus certificate	FM16US0122X
cFM certificate	FM16CA0067X
Marking cFMus	Class I, Div. 2, Groups A,B,C,D; Class I, Zone 2, Group IIC AIS Class I,II,III, Div. 1, Groups A,B,C,D,E,F,G; Class I, Zone 0, [AEx ia]/[Ex ia] IIC T4 at Ta = 70°C See Doc. 91 826 01 31 1
Certificate ULus	E81680
Marking ULus	providing intrinsically safe circuits for use in Class I,II,III, GROUPS A,B,C,D,E,F,G; See Doc. 91 826 01 31 3
Certificates	ATEX (BVS), Brazil (ULB), Canada (FM), China (NEPSI), IECEX (BVS), India (PESO), Korea (KTL), USA (FM), USA (UL)
Ship approval	CCS, EU RO MR (DNV)
Declaration of Conformity	ATEX (EUK), China (CCC)
Installation	in Zone 2, Division 2 and in the safe area

Isolator Barriers

Temperature transmitter

Ex i field circuit ISpac

9182/20-51-11k Art. No. 160544



Explosion Protection

Further information	see respective certificate and operating instructions
---------------------	---

Safety Data

Max. voltage U_o/V_{oc}	6.5 V
Max. current I_o/I_{sc}	19.7 mA
Max. power P_o	32 mW
Max. power P_o note	Linear characteristic curve
Max. permissible external capacitance C_o/C_a for IIC	25 μ F
Max. permissible external capacitance C_o/C_a for IIB	570 μ F
Max. permissible external inductance L_o/L_a for IIC	90 mH
Max. permissible external inductance L_o/L_a for IIB	330 mH
Max. permissible external capacity C_o for IIIC	570 μ F
Max. permissible external inductance L_o for IIIC	330 mH
Internal capacitance	Negligible
Internal inductance	Negligible
Safety-related max. voltage	253 V

Electrical Data

Number of channels	2
LFD relay	Yes

Isolator Barriers

Temperature transmitter

Ex i field circuit ISpac

9182/20-51-11k Art. No. 160544



Electrical connection	Input configuration				
	Thermocouple	Reference junction			
		Const. temp.	Ext. Pt. 100		
Channel 2					
Channel 1					
Resistance temperature detector	2-wire	3-wire	4-wire (1 channel)	4-wire (2 channels)	
Channel 2					
Channel 1					
*) Connection of two sensors using 4-wire technology requires an additional external terminal X1					
Potentiometer	3-wire				
Channel 2					
Channel 1					

Auxiliary Power

Auxiliary power	24 V DC
Nominal voltage V_{nom}	24 V DC
Auxiliary power voltage range	18 to 31.2 V
Voltage range residual ripple	$\leq 3,6 V_{SS}$
Nominal current	80 mA
Power consumption	1.9 W
Max. power dissipation	1.9 W
Polarity reversal protection	Yes
Undervoltage monitoring	Yes
Undervoltage monitoring note	no faulty devices / output states
Operation indication	Green "PWR" LED

Galvanic Isolation

Test voltage as per standard	IEC EN 60079-11
Ex i input to output	1.5 kV AC
Ex i input to auxiliary power	1.5 kV AC
Ex i input to fault message contact	1.5 kV AC
Test voltage as per standard	EN 50178
Output to auxiliary power	350 V AC
Output to output	350 V AC
Fault message contact to auxiliary power	350 V AC

Isolator Barriers

Temperature transmitter

Ex i field circuit ISpac

9182/20-51-11k Art. No. 160544



Galvanic Isolation

Fault message contact to output 350 V AC

Input

2-conductor adjustment	Via ADJ DIP switch					
Sensor adjustment	Via software or DIP switch					
Input for resistance temperature detector	See table					
Connection type RTD input	2-, 3- and 4-wire circuits					
RTD linearisation	Temperature/resistance					
Sensor current RTD	≤ 0.25 mA					
Max. line resistance per wire RTD	50 Ω (2-wire connection) 100 Ω (3-, 4-wire connection)					
Max. line resistance per loop thermocouple	1000 Ω					
Input thermocouple	Types B, E, J, K, N, R, S, T, L, U, XK					
Linearisation thermocouple	Temperature/voltage					
External reference junction	Pt100 2-conductor connection					
Potentiometer input	Up to 100 kΩ					
Potentiometer connection type	3-conductor connection					
Potentiometer sensor current	≤ 0.25 mA					
Input resistance temperature detector (RTD)	Types	Standard	Basic range	Min. span	Middle resolution	Middle measurement error
	Pt100 Pt500 Pt1000	IEC 60751	-200 ... +850 °C	50 K	0,1 K	0.35 K
	Pt250	IEC 60751	-200 ... +850 °C	40 K	0,1 K	0.5 K
	Pt2000	IEC 60751	-200 ... +850 °C	40 K	0,1 K	0.35 K
	Ni100 Ni500 Ni1000	DIN 43760	-60 ... +180 °C	31 K	0,1 K	0.25 K
	PT100	GOST 6651-94	-200 ... +1100 °C	40 K	0.1 K	0.7 K
	M50	GOST 6651-94	-200 ... +200 °C	70 K	0.1 K	0.7 K
	M53	GOST 6651-94	0 ... +120 °C	70 K	0.1 K	0.5 K
	M100	GOST 6651-94	-200 ... +200 °C	40 K	0.1 K	0.45 K

Isolator Barriers

Temperature transmitter

Ex i field circuit ISpac

9182/20-51-11k Art. No. 160544



Input thermocouple	Types	Standard	Basic range	Min. span	Middle resolution	Middle measurement error
	B	IEC 60584-1	250 ... +1800 °C	314 K	0.1 K	1.2 K
	E		-200 ... +1000 °C	36 K	0.1 K	0.2 K
	J		-200 ... +1200 °C	42 K	0.1 K	0.2 K
	K		-200 ... +1370 °C	63 K	0.1 K	0.3 K
	N		-200 ... +1300 °C	75 K	0.1 K	0.3 K
	R		-50 ... +1767 °C	171 K	0.1 K	0.7 K
	S		-50 ... +1767 °C	185 K	0.1 K	0.8 K
	T		-200 ... +400 °C	60 K	0.1 K	0.3 K
	L	DIN 43710	-200 ... +900 °C	55 K	0.1 K	0.3 K
	U		-200 ... +600 °C	48 K	0.1 K	0.3 K
	XK	GOST	-200 ... +800 °C	50 K	0.1 K	0.2 K

Input potentiometer	Basic measuring range	Middle measurement error
	50 ... 500 Ω	0.1 Ω
	0.5 ... 5 kΩ	1 Ω
	1 ... 10 kΩ	2 Ω
	10 ... 100 kΩ ^{*)}	-- ^{*) with parallel 10 kΩ Shunt, no open-circuit detection}

Output

Output	0/4 to 20 mA active/source
Output signal	0/4 to 20 mA (configurable)
Function range output	0.0-21 mA
Load resistance R _L	0 ... 600 Ω
Output signal resolution	≤ 1 µA
Settling time output	≤ 35 ms
Response time output	≤ 500 ms
Average measurement fault	< 0,1%
Limit contact (per channel)	without
Fault message contact switching capacity	30 V / 100 mA
Wire breakage error detection input	> 1 kΩ
LF switch user adjustment	Activated/deactivated
Indication of line fault	Red "LF" LED
Deviations / error note	Information in % of the measuring range (20 mA) at U _n , 23 °C
Wire breakage error detection input note	for resistance temperatur detectors, thermocouples and resistance transmitters
Short circuit error detection input note	for resistance temperatur detectors with temperature linearisation and for resistance transmitters
Behaviour of the output at line fault	configurable
Line fault and loss of power signalization	- Contact (30 V/100 mA), closed against earth in case of error - pac-Bus, potential-free contact (30 V/100 mA)

Ambient Conditions

Ambient temperature °C	-20 °C ... +70 °C (Single device) -20 °C ... +60 °C (Group assembly)
------------------------	---

Isolator Barriers

Temperature transmitter

Ex i field circuit ISpac

9182/20-51-11k Art. No. 160544



Ambient Conditions

Ambient temperature °F	-4°F ... +158°F (Single device) -4°F ... +140°F (Group assembly)
Note	The installation conditions affect the ambient temperature. Observe the "Cabinet installation guide".
Storage temperature °C	-40 °C ... +80 °C
Storage temperature °F	-40°F ... +176°F
Max. relative humidity	95%
Max. additional relative humidity	No condensation
Temperature influence	≤ 0,25 %/10K
Use at the height of	< 2000 m
Electromagnetic compatibility	Tested to the following standards and regulations: EN 61326-1 For use in industrial areas; NAMUR NE 21

Mechanical Data

Degree of protection (IP)	IP30
Degree of protection (IP) terminals	IP20
Fire resistance (UL 94)	V0
Enclosure material	Polyamide
Grid dimension	17.6 mm
Width	17.6 mm
Width, inches	0.69 in
Height	114.5 mm
Length	128 mm
Length, inches	5.04 in
Mounting depth, inches	4.51 in
Weight	195 g
Weight	0.43 lb

Mounting / Installation

Mounting type	DIN rail NS35/15, NS35/7.5
Mounting orientation	Horizontal Vertical
Connection type	Spring clamp terminal
Min. rigid conductor cross section	0.2 mm ²
Max. rigid conductor cross section	2.5 mm ²
Min. flex conductor cross section	0.2 mm ²
Max. flex conductor cross section	2.5 mm ²
Connection cross-section AWG	24 ... 14

Isolator Barriers

Temperature transmitter

Ex i field circuit ISpac

9182/20-51-11k Art. No. 160544



Technical Drawings – Subject to Alterations

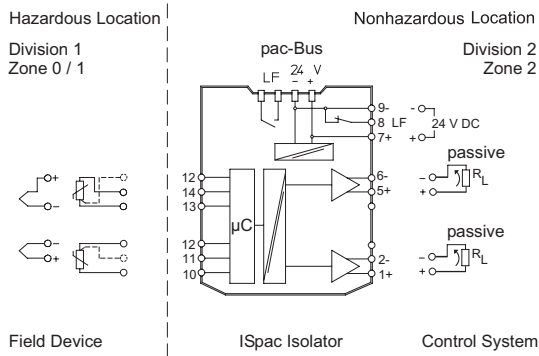

Connection diagram 9182/20-51-11

Dimensional Drawings (All Dimensions in mm [inches]) – Subject to Alterations

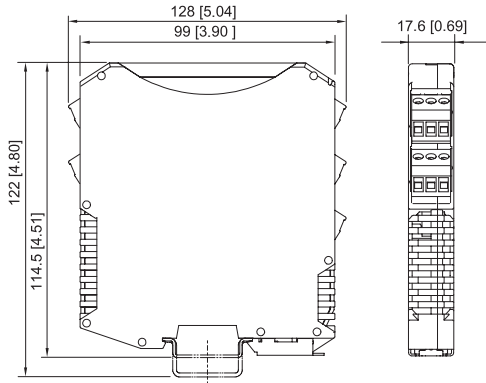

ISpac Series 9146, 9147, 9160, 9162, 9163, 9165, 9167, 9170, 9172, 9175, 9176, 9180, 9182, 9193, Fieldbus Power Supply Series 9412 with spring clamp terminal

Accessories

Parameterization set ISpac - Wizard

	Art. No.
 <p>The software serves for commissioning, configuring and diagnosing the ISpac isolators Series 9146, 9162, 9182 and 9282. For further information, see operating instructions. Form of delivery: USB stick; parameterization software incl. parameterization cable / adaptor System requirements: IBM compatible PC with MS XP, Vista, Windows 7, 10 RS 232 C interface RS 232 / USB adaptor</p>	202595

9182 Parameterisation

	Art. No.
 <p>Parameterisation ex works optionally available for all variants.</p>	270433

Resistive coupling element

	Art. No.
 <p>The 0/4 to 20 mA signal of channel 1 is converted to a 0/2 to 10 V signal. The resistive coupling element replaces the existing connection terminal. (Set with 5 pieces)</p>	273968

Isolator Barriers

Temperature transmitter



Ex i field circuit ISpac

9182/20-51-11k Art. No. 160544



External reference junction



Art. No.

	External reference junction for 2 x thermocouple (1 x Pt100 for 2-, 3- or 4-wire connection) integrated into the 4-pin terminal block. Mounted on a DIN rail.	160675
	External reference junction for 1 x thermocouple (Pt100 in 2-wire connection) integrated into the pluggable terminal (3-pin). Mounted in the ISpac device instead of the standard connection terminal.	160676

Spare Parts



Screw terminal

Art. No.

	3-pole plug, screw connector thread: M3 stripping length: 7 mm color: green	112817
	3-pole plug, screw connector thread: M3 stripping length: 7 mm color: black	112816
	3-pole plug, screw connector thread: M3 stripping length: 7 mm color: blue	112818



Screw terminal with test tap

Art. No.

	3-pole plug with test tap, screw connector thread: M3 stripping length: 7 mm colour: black	113005
	3-pole plug with test tap, screw connector thread: M3 stripping length: 7 mm colour: blue	113004

Spring clamp terminal

Art. No.

	3-pole plug with test tap, spring clamp connection stripping length: 10 mm color: green	112825
	3-pole plug with test tap, spring clamp connection stripping length: 10 mm color: black	112824
	3-pole plug with test tap, spring clamp connection stripping length: 10 mm color: blue	112826

Isolator Barriers

Temperature transmitter

Ex i field circuit ISpac

9182/20-51-11k Art. No. 160544



We reserve the right to make alterations to the technical data, dimensions, weights, designs and products available without notice. The illustrations cannot be considered binding.