

Isolator Barriers

Temperature transmitter

Ex i field circuit ISpac

9182/10-51-14s Art. No. 201682



- Ex i temperature transmitter, can be configured for virtually any common sensor type
- Broad range, including variants with signal conversion and trip amplifier function
- Can be used up to SIL 2 (IEC/EN 61508)

WebCode **9182A**



9182 series Ex i temperature transmitters for field circuits can be used to connect temperature sensors and potentiometers. They are easy to configure for virtually any sensor type by means of software or a DIP switch. These sensor types include Pt100 sensors, thermocouples and potentiometers. Variants with a trip amplifier function allow the input signal to be analysed using two independent contacts.

Technical Data

Explosion Protection

Application range (Zones)	2
Ex interface zone	0 1 2 20 21 22
IECEX certificate Gas	IECEX BVS 09.0046 X
IECEX gas explosion protection	Ex nA nC [ia Ga] IIC T4 Gc
IECEX dust certificate	IECEX BVS 09.0046 X
IECEX dust explosion protection	[Ex ia Da] IIIC
ATEX gas certificate	DMT 02 ATEX E 243 X
ATEX gas explosion protection	⊕ II 3 (1) G Ex nA nC [ia Ga] IIC T4 Gc
ATEX dust certificate	DMT 02 ATEX E 243 X
ATEX dust explosion protection	⊕ II (1) D [Ex ia Da] IIIC
Certificate FMus	FM16US0122X
Certificate cFM	FM16CA0067X
Marking cFMus	Class I, Div. 2, Groups A,B,C,D; Class I, Zone 2, Group IIC AIS Class I,II,III, Div. 1, Groups A,B,C,D,E,F,G; Class I, Zone 0, [AEx ia]/[Ex ia] IIC T4 at Ta = 70°C See Doc. 91 826 01 31 1
EAC certificate	EAEU RU S-DE.HA91.B.00100/20
EAC certificate valid until	2025-01-26
EAC gas explosion protection	⊕ 2 Ex nA nC [ia Ga] IIC T4 Gc X
EAC dust explosion protection	⊕ [Ex ia Da] IIIC X

Isolator Barriers

Temperature transmitter

Ex i field circuit ISpac

9182/10-51-14s Art. No. 201682



Explosion Protection

Certificates	ATEX (BVS), Brazil (ULB), Canada (FM), EAC (ENDCE), IECEx (BVS), India (PESO), Korea (KTL), Russia (Meteorological certificate), SIL (exida), USA (FM)
Ship approval	CCS, EU RO MR

Safety Data

Max. voltage U_o/V_{oc}	6.5 V
Max. current I_o/I_{sc}	19.7 mA
Max. power P_o	32 mW
Max. permissible external capacitance C_o/C_a for IIC	25 μ F
Max. permissible external capacitance C_o/C_a for IIB	570 μ F
Max. permissible external inductance L_o/L_a for IIC	90 mH
Max. permissible external inductance L_o/L_a for IIB	330 mH
Internal capacitance C_i	Negligible
Internal inductance L_i	Negligible
Safety-related maximum voltage	253 V

Functional Safety

SIL	2
-----	---

Electrical Data

Signal types	Input temperature
Number of channels	1
LFD relay	Yes
External reference junction	Pt100 2-wire connection

Auxiliary Power

Auxiliary power	24 V DC
Nominal voltage V_{nom}	24 V DC
Auxiliary power voltage range	18 ... 31.2 V
Voltage range residual ripple	$\leq 3,6 V_{SS}$
Nominal current	70 mA
Power consumption	1.9 W
Power dissipation max.	1.9 W
Polarity reversal protection	Yes
Undervoltage monitoring	Yes
Operation indication	Green "PWR" LED

Galvanic Isolation

Test voltage according to standard	IEC EN 60079-11
Galvanic isolation Ex i input to output	1.5 kV AC
Galvanic isolation Ex i input to auxiliary power	1.5 kV AC
Galvanic isolation Ex i input to fault message contact	1,5 kV AC
Test voltage according to standard 2	EN 50178
Galvanic isolation output to auxiliary power	350 V AC

Isolator Barriers

Temperature transmitter

Ex i field circuit ISpac

9182/10-51-14s Art. No. 201682



Galvanic Isolation

Galvanic isolation output to output	350 V AC
Galvanic isolation fault message contact to auxiliary power	350 V AC
Galvanic isolation fault message contact to output	350 V AC

Input

RTD input	2-,3-,4-wire circuits
Sensor current	≤ 0,25 mA
2-wire compensation adjustment	via DIP switch ADJ
Sensor adjustment	via software
Max. line resistance	≤ 1 Ω
Line fault and loss of power signalization	Contact (30 V / 100 mA) closed to ground in case of fault pac-Bus, floating contact (30 V / 100 mA)
Input thermocouple	Types B, E, J, K, N, R, S, T, L, U, XK
Input for potentiometer	Up to 100 kΩs
Input for resistance temperature detector	See table
Input resistance temperature detector (RTD)	Types Pt 100, Pt 500, Pt 1000, Ni 100, Ni 500, Ni 1000
Input potentiometer	3-wire connection
Sensor current potentiometer	≤ 0,25 mA

Output

Output	0/4 ... 20 mA active / source
Output signal	0/4 – 20 mA (configurable)
Settling time output	≤ 35 ms
Response time output	≤ 500 ms
Output functional range	0 – 21 mA
Load resistance R_L max.	750 Ω
Limit contact (per channel)	2 NO / NC
Switching voltage limiting values	≤ ± 30 V
Switching current limiting values	≤ 100 mA
Switching state indication	LED yellow "A, B"
Switching capacity fault message contact	30 V / 100 mA
Switch user adjustment line fault	Activated / deactivated
Indication of line fault	"LF" LED, red
Error detection wire breakage	> 1 kΩ
Behaviour of the output at wire breakage	selectable
Average measurement fault	< 0,1%

Ambient Conditions

Ambient temperature °C	-20 °C ... +70 °C (Single device) -20 °C ... +60 °C (Group assembly)
Ambient temperature °F	-4°F ... +158°F (Single device) -4°F ... +140°F (Group assembly)
Storage temperature °C	-40 °C ... +80 °C
Storage temperature °F	-40°F ... +176°F
Max. relative humidity	95%
Temperature influence	≤ 0,25 %/10K

Isolator Barriers

Temperature transmitter

Ex i field circuit ISpac

9182/10-51-14s Art. No. 201682



Ambient Conditions

Use at the height of < 2000 m

Mechanical Data

Degree of protection (IP)	IP30
Terminal degree of protection (IP)	IP20
Fire resistance (UL 94)	V0
Connection cross-section	0.2-2.5 mm ² flexible 0.2-2.5 mm ² rigid 0.25-2.5 mm ² flexible core end sleeve
Enclosure material	Polyamide
Clamping range AWG	16 – 12
Connection cross-section AWG	16 ... 12
Grid dimension	17.6 mm
Width inches	0.69 in
Length inches	4.25 in
Mounting depth inches	4.51 in
Weight	0.17 kg
Weight	0.37 lb

Mounting / Installation

Mounting type	NS35/15, NS35/7.5 DIN rail
Mounting position	Vertical Horizontal
Connection type	Screw terminal
Conductor cross-section solid min.	0.2 mm ²
Conductor cross-section solid max.	2.5 mm ²
Conductor cross-section flexible min.	0.2 mm ²
Conductor cross-section flexible max.	2.5 mm ²

Technical Drawings – Subject to Alterations

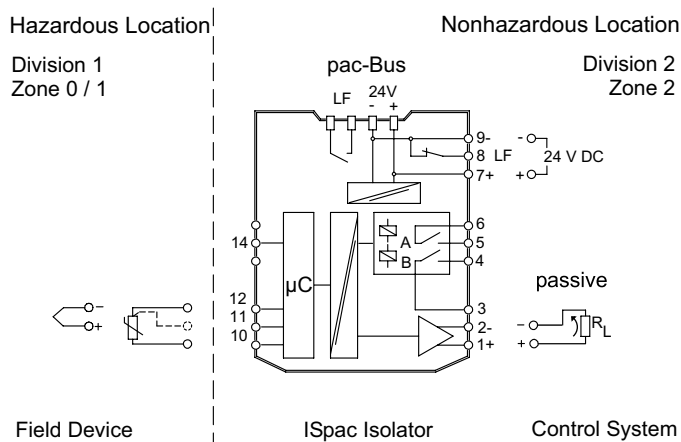

Connection diagram 9182/10-51-12; 9182/10-51-14

Isolator Barriers

Temperature transmitter

Ex i field circuit ISpac

9182/10-51-14s Art. No. 201682



Dimensional Drawings (All Dimensions in mm [inches]) – Subject to Alterations

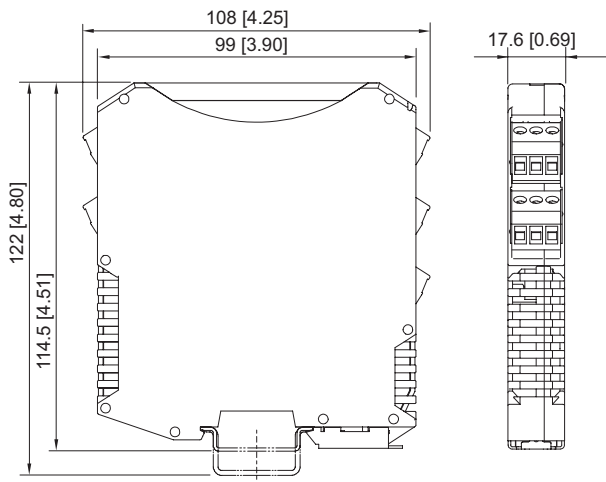

ISpac Series 9146, 9147, 9160, 9162, 9163, 9165, 9167, 9170, 9172, 9175, 9176, 9180, 9182, 9193, ISbus Series 9412 with screw terminal

Accessories

Parameterization set ISpac - Wizard

Art. No.



The software serves for commissioning, configuring and diagnosing the ISpac isolators Series 9146, 9162, 9182 and 9282.
For further information, see operating instructions.
Form of delivery: USB stick; parameterization software incl. parameterization cable / adaptor
System requirements:
IBM compatible PC with MS XP, Vista, Windows 7, 10
RS 232 C interface
RS 232 / USB adaptor

202595

Resistance coupling element

Art. No.



The 0/4 to 20 mA signal of channel 1 is converted to a 0/2 to 10 V signal. The resistive coupling element replaces the available connection terminal. (Set with 5 pieces)

273968

External reference junction

Art. No.



External reference junction for 2 x thermocouple (1 x Pt100 for 2, 3 or 4 wire connection) integrated into the 4-pole terminal block. Installation takes place on the DIN rail.

160675



External reference junction for 1 x thermocouple (Pt100 in 2 wire connection) integrated into the pluggable terminal (3-pole). Installation takes place in the ISpac device instead of the standard terminal.

160676

Spare Parts

Screw terminal

Art. No.



Isolator Barriers

Temperature transmitter

Ex i field circuit ISpac



9182/10-51-14s Art. No. 201682



	3-pole plug, screw connector thread: M3 stripping length: 7 mm color: green	112817
	3-pole plug, screw connector thread: M3 stripping length: 7 mm color: black	112816
	3-pole plug, screw connector thread: M3 stripping length: 7 mm color: blue	112818



Screw terminal with test tap

Art. No.

	3-pole plug with test tap, screw connector thread: M3 stripping length: 7 mm colour: black	113005
	3-pole plug with test tap, screw connector thread: M3 stripping length: 7 mm colour: blue	113004

Spring clamp terminal

Art. No.

	3-pole plug with test tap, spring clamp connection stripping length: 10 mm color: green	112825
	3-pole plug with test tap, spring clamp connection stripping length: 10 mm color: black	112824
	3-pole plug with test tap, spring clamp connection stripping length: 10 mm color: blue	112826

We reserve the right to make alterations to the technical data, dimensions, weights, designs and products available without notice. The illustrations cannot be considered binding.