

Isolator Barriers

Loop-powered binary output

Ex i field circuit

9176/20-16-00s Art. No. 222184



- Comprehensive portfolio to cater for all characteristics
- Two-channel variants reduce the amount of space required
- Can be used up to SIL 3 (IEC/EN 61508)

MY R. STAHL 9176A



9176 series binary outputs issue binary signals for the intrinsically safe operation of Ex i solenoid valves, indicator lamps or horns. The devices do not require a separate auxiliary power supply as they are powered by the control circuit. The intrinsically safe outputs are galvanically separated from the inputs. The two-channel variants are characterised by galvanically separated channels.

Technical Data

Explosion Protection	
Application range (zones)	2
Ex interface zone	0, 1, 2, 20, 21, 22
IECEX gas certificate	IECEX BVS 13.0012 X
IECEX gas certificate	IECEX BVS 13.0012 X
IECEX gas explosion protection	Ex nA [ia Ga] IIC T4 Gc
IECEX dust certificate	IECEX BVS 13.0012 X
IECEX dust explosion protection	[Ex ia Da] IIIC
ATEX gas certificate	BVS 04 ATEX E 075 X
ATEX gas certificate	BVS 04 ATEX E 075 X
ATEX gas explosion protection	⊕ II 3 (1) G Ex nA [ia Ga] IIC T4 Gc
ATEX dust certificate	BVS 04 ATEX E 075 X
ATEX dust explosion protection	⊕ II (1) D [Ex ia Da] IIIC
FMus certificate	FM16US0122X
cFM certificate	FM16CA0067X
Marking cFMus	Class I, Div. 2, Groups A,B,C,D; Class I, Zone 2, Group IIC AIS Class I,II,III, Div. 1, Groups A,B,C,D,E,F,G; Class I, Zone 0, [AEx ia]/[Ex ia] IIC T4 Mounting vert. at Ta = 70°C , or horizontal Ta = 60°C See Doc. 91 766 01 31 1
Certificates	ATEX (BVS), Brazil (ULB), Canada (FM), China (NEPSI), IECEX (BVS), Korea (KTL), SIL (exida), USA (FM)
Ship approval	CCS, EU RO MR (DNV)
Declaration of Conformity	ATEX (EUK), China (CCC)
Safety Data	
Max. voltage U_o/V_{oc}	27.6 V
Max. current I_o (Ex ia)	110 mA

Isolator Barriers

Loop-powered binary output

Ex i field circuit

9176/20-16-00s Art. No. 222184



Safety Data

Max. current I_o (Ex ib)	50 mA
Max. power P_o	760 mW
Max. permissible external capacitance C_o/C_a for IIC	0.085 μ F
Max. permissible external inductance L_o/L_a for IIC	1.2 mH
Max. permissible external capacitance C_o/C_a for IIB	0.667 μ F
Max. permissible external inductance L_o/L_a for IIB	9 mH
Internal capacitance	1.1 nF
Internal inductance	Negligible
Max. voltage U_o parallel	27.6 V
Max. power P_o parallel	1520 mW
Max. current I_o (Ex ia) paral.	220 mA
Max. current I_o (Ex ib) paral.	100 mA
Internal capacitance parallel	2.2 nF
Internal inductance parallel	negligible
Safety-related max. voltage	253 V
Intrinsically safe limiting values inductance L_o /capacitance C_o	Max. connectable inductance L_o /capacitance C_o , 2 parallel channels
IIC	L_o [mH] C_o [μ F]
IIB	L_o [mH] C_o [μ F]
IIIC	L_o [mH] C_o [μ F]

Functional Safety

SIL	3
HFT	0
SFF	100%
Lambda SD	0 FIT
Lambda SU	364 FIT
Lambda DD	0 FIT
Lambda DU	0 FIT

Electrical Data

Number of channels	2
Internal resistance R_i	250 Ω

Auxiliary Power

Auxiliary power	without
Auxiliary power consumption	0.5 W + (I_a x 37 mW/mA)
Polarity reversal protection	Yes

Galvanic Isolation

Test voltage as per standard	IEC EN 60079-11
Galvanic separation Ex i output to input	1,5 kV AC
Ex i input to Ex i input	500 V AC

Isolator Barriers

Loop-powered binary output

Ex i field circuit

9176/20-16-00s Art. No. 222184



Galvanic Isolation

Test voltage as per standard	EN 50178
Input to input	350 V AC

Input

Input	In accordance with EN 61131-2
Input voltage for ON	18 – 31.2 V
Input voltage for OFF	0 – 5 V
Control Power P_E	0.5 W+ ($I_A \times 37$ mW/mA) (with I_A = max. required output current)

Output

Output open-circuit voltage U_a	25 V
Max. output current $I_{a\max}$	35 mA
Internal Resistance R_i	250 Ω /parallel: 125 Ω^*
Max. output current I_a note	Parallel channels: 70 mA
Internal resistance R_i note	250 Ω /parallel: 125 Ω
Output residual ripple	< 100 mV
Output switching frequency	\leq 10 Hz
Switching delay ON/OFF	\leq 50 ms
Switching delay OFF/ON	\leq 18 ms
Switching state indication	LED

9175/0-16-11; 9176/0-16-00 output characteristic

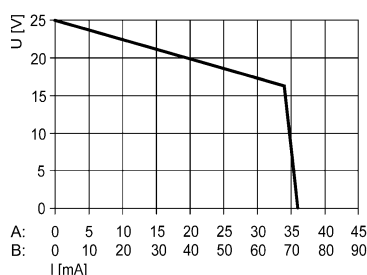

At U_N ; -20 to +60 °C

X axis (I [mA])

A: Characteristic curve for each channel

B: Characteristic curve for channel 1, parallel channel 2 (only types 9176/20-...-...)

Ambient Conditions

Ambient temperature °C	-20 °C ... +70 °C (Single device) -20 °C ... +60 °C (Group assembly)
Ambient temperature °F	-4 °F ... +158 °F (Single device) -4 °F ... +140 °F (Group assembly)
Note	The installation conditions affect the ambient temperature. Observe the "Cabinet installation guide".
Storage temperature °C	-40 °C ... +80 °C
Storage temperature °F	-40 °F ... +176 °F
Max. relative humidity	95%
Use at the height of	< 2000 m
Electromagnetic compatibility	Tested to the following standards and regulations: EN 61326-1 For use in industrial areas; NAMUR NE 21

Mechanical Data

Degree of protection (IP)	IP30
Degree of protection (IP) terminals	IP20
Fire resistance (UL 94)	V0
Enclosure material	Polyamide
Grid dimension	17.6 mm

Isolator Barriers



Loop-powered binary output

Ex i field circuit

9176/20-16-00s Art. No. 222184

Mechanical Data

Width	17.6 mm
Width, inches	0.69 in
Height	114.5 mm
Height in inches	4.51 in
Length	108 mm
Length in inches	4.25 in
Weight	185 g
Weight	0.41 lb

Mounting / Installation

Mounting type	DIN rail NS35/15, NS35/7.5
Mounting orientation	Vertical Horizontal
Connection type	Screw terminal
Min. rigid conductor cross section	0.2 mm ²
Max. rigid conductor cross section	2.5 mm ²
Min. flex conductor cross section	0.2 mm ²
Max. flex conductor cross section	2.5 mm ²
Connection cross-section AWG	24 ... 14

Technical Drawings – Subject to Alterations

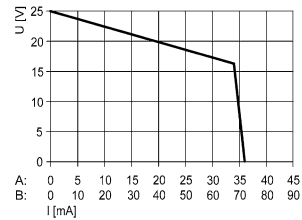

9175/0-16-11; 9176/0-16-00 output characteristic

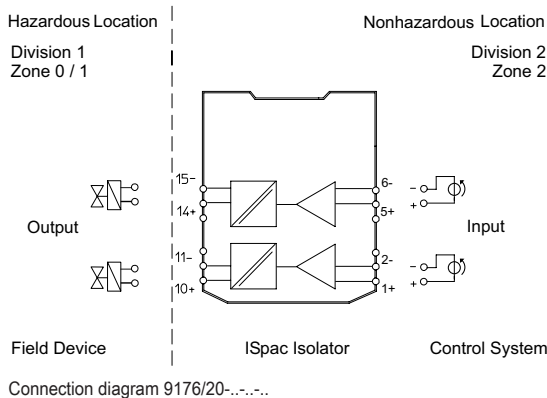
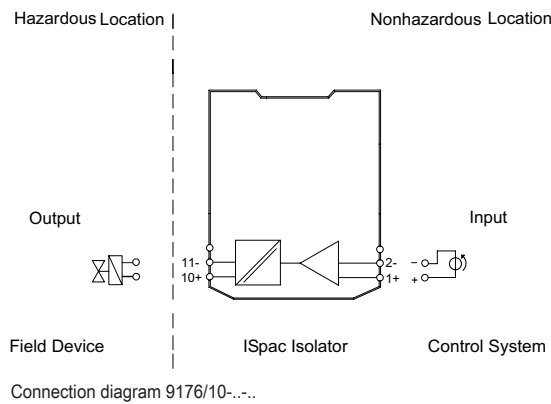

Accessories

Transparent cover

Art. No.

Isolator Barriers

Loop-powered binary output

Ex i field circuit



9176/20-16-00s Art. No. 222184





	For 91xx ISpac modules Yellow, transparent Clear identification of the device for SIL applications. (Packaging unit: 10 pieces)	200914
--	--	--------

Spare Parts



Screw terminal Art. No.

	3-pole plug, screw connector thread: M3 stripping length: 7 mm color: green	112817
	3-pole plug, screw connector thread: M3 stripping length: 7 mm color: black	112816
	3-pole plug, screw connector thread: M3 stripping length: 7 mm color: blue	112818

Screw terminal with test tap Art. No.

	3-pole plug with test tap, screw connector thread: M3 stripping length: 7 mm colour: black	113005
	3-pole plug with test tap, screw connector thread: M3 stripping length: 7 mm colour: blue	113004

Spring clamp terminal Art. No.

	3-pole plug with test tap, spring clamp connection stripping length: 10 mm color: green	112825
	3-pole plug with test tap, spring clamp connection stripping length: 10 mm color: black	112824
	3-pole plug with test tap, spring clamp connection stripping length: 10 mm color: blue	112826

We reserve the right to make alterations to the technical data, dimensions, weights, designs and products available without notice. The illustrations cannot be considered binding.